The Advantages Of A Varying Length Segmented Foil Tape In Category 6A UTP Cable





Introduction

With the growth of 10GBASE-T ports, new cabling installations will continue to specify Category 6A channels to support the higher 10 gigabit data rates. As legacy networks are upgraded to 10GBASE-T equipment, lower category cable infrastructure (e.g., Category 6, Category 5e) will also need to be upgraded to Category 6A. Typical Category 6A cabling is larger in diameter than the legacy Category 6 and 5e cables. One driver for the larger cable diameter is the alien crosstalk requirements imposed on Category 6A channels.

Alien crosstalk results from unwanted electromagnetic coupling between conductors in adjacent cables tightly bundled or packed together. A simple and direct method to reduce the coupling between adjacent cables is to create more physical separation between the conductors of the cables. A large cable diameter will inherently create more distance between the conductors in a victim cable and the conductors in the neighboring cables. While this method has proven effective, especially in early Category 6A cable designs, it comes at a price of larger cable diameters.

Larger diameter cables reduce the effective capacity of raceways, ladder rack, and other cable routing infrastructure. More cable management elements may also be required to properly install larger diameter Category 6A cabling compared to Category 6 and 5e. For networks looking to upgrade to Category 6A cabling, this may prove too expensive or impossible in scenarios where the number of cables needed will not fit in their existing pathways. In an ideal scenario, the same infrastructure that routed and managed the lower category cabling could route and manage the same number of Category 6A cables. In the years since the introduction of Category 6A cabling, cable designers have put great effort into reducing Category 6A cable diameters while still satisfying the alien crosstalk requirements.

This white paper begins by discussing the cable diameter and alien crosstalk advantages of using a metallic tape wrapped around the Category 6A twisted pairs. While a solid tape (non-discontinuous) can have these size and performance advantages, the solid tape degrades the electromagnetic compatibility (EMC) performance when compared to tapes with random cuts. The random discontinuous cuts in the Vari-MaTriX cable allow it to have the same cable diameter and alien crosstalk advantages of solid tapes, while also providing superior EMC performance. The superior EMC performance is reflected in both the radiated emissions and immunity characteristics of the cable. This white paper provides a detailed explanation and example of how the Vari-MaTriX cable is able to accomplish this improvement in immunity to EMI.

Evolution of Category 6A Cable Diameters

One method which Panduit introduced to the market in 2007 incorporated a metallic foil barrier with discontinuous segments wrapped around the twisted pairs (MaTriX). The discontinuous metallic foil effectively attenuates the magnetic coupling from adjacent cables, thereby reducing alien crosstalk. This is accomplished through the following mechanisms:

- Data propagating along the four pairs of twisted conductors inside a cable creates an electric and magnetic field transverse to the direction of propagation
- The magnetic field from one aggressor pair (pair that creates alien crosstalk noise) induces a current in the victim pairs (pairs that receive alien crosstalk noise) of nearby cables proportional to the magnitude of the aggressor’s magnetic field
- When the magnetic field from the aggressor encounters the metallic foil, it creates an eddy current in the metallic foil which induces an opposing magnetic field
- The net effect of the two opposing magnetic fields is a reduction in the magnitude of the aggressor’s magnetic field seen by the victim pairs within the metallic foil of nearby cables
- With this reduction in magnetic coupling, smaller diameter cables can be bundled together while still satisfying alien crosstalk requirements

Size constraints of traditional Category 6A UTP (unshielded) cable designs are typically driven by the alien crosstalk requirement. With Panduit’s Vari-MaTriX design, the discontinuous metallic foil barrier provides far superior alien crosstalk performance, thereby removing the traditional constraints on cable size. Instead of alien crosstalk dictating minimum cable sizes, the Vari-MaTriX cable size is limited primarily by the wire gauge of the internal conductors. The result is a Category 6A cable similar in size to lower category cables and alien crosstalk performance superior to traditional UTP. The history of Category 6A cable sizes at Panduit is shown in Figure 1.

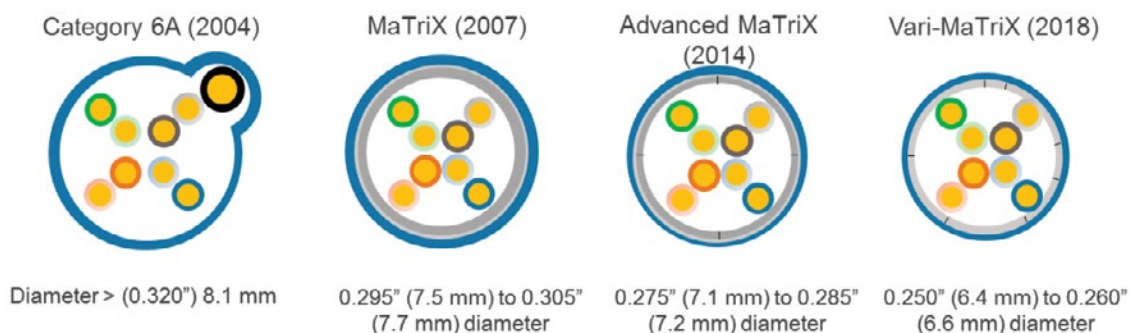

Figure 1. Category 6A Cable History at Panduit.

Design Challenges

Others in the industry have since incorporated metallic barriers in their UTP cable designs to take advantage of the size and alien crosstalk enhancements. However, some of these cables implement a continuous foil barrier (floating shield) which can degrade the electromagnetic immunity performance of a system due to the foil being unterminated. Using this type of cable construction in a UTP channel equates to using an unterminated F/UTP shielded cable (foil around a twisted pair). Large foil discontinuities are created at each UTP jack and plug interface because the continuous shield does not get terminated. Some in the industry have incorporated discontinuous metallic barriers with fixed length discontinuous segments. While these designs may be an improvement over continuous unterminated foil barriers with respect to immunity, they can still be prone to specific in-band and/or out-of-band EMC weaknesses depending on the fixed length of the discontinuous segments. The discontinuous and variable length nature of the metallic barrier in Panduit's Vari-MaTriX cable prevents any degradation to the EMC performance of a system whether in-band or out-of-band. A comparison of the foil designs is shown in Figure 2.

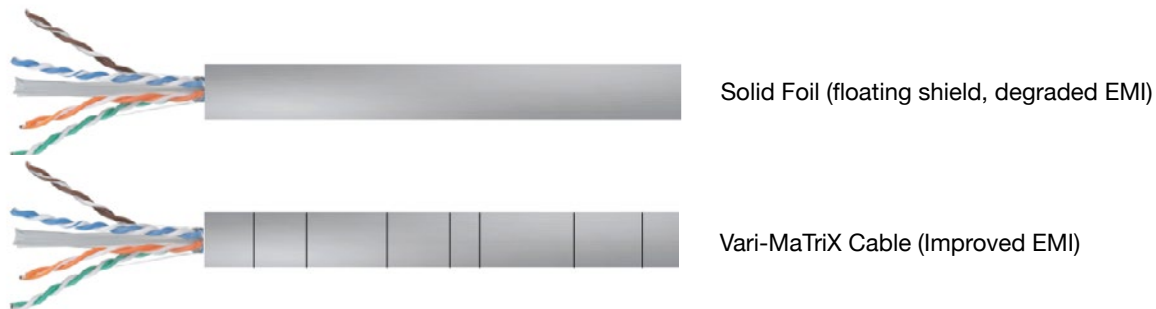
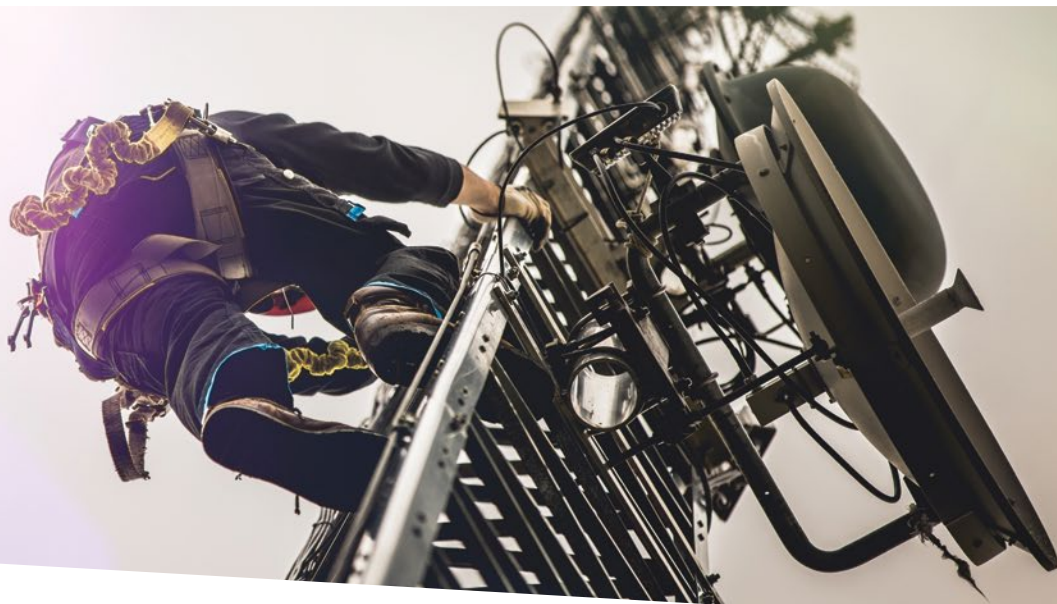

Figure 2. Example of Solid Foil and Vari-MaTriX Cable.

This information shows the impact of these unterminated foil barriers on the electromagnetic immunity of a cable and how it can affect 10GBASE-T communication compared to Vari-MaTriX cable and traditional UTP cable. The measurements reveal that cables with unterminated foil barriers can degrade the EMC performance of a system by a factor of 3. In a live network connected by cabling with floating shields, the heightened sensitivity to electromagnetic interference (EMI) can translate to higher rates of packet errors and dropped links leading to severe throughput limitations. Panduit's Vari-MaTriX cable avoids this unnecessary EMC risk while still providing industry-leading cable diameter and alien crosstalk performance.



Antenna Phenomenon

Metallic solid foils are typically only found in shielded cables. When these cables with solid foils are assembled into a channel where they are properly grounded to shielded jacks and plugs, the shielded system provides excellent EMC performance with respect to both radiated emissions and immunity to electromagnetic interference (EMI). In certain harsh industrial environments where motors, generators, welders, and other heavy machinery may be present, shielded cabling systems may be the best choice to ensure error-free communication over the network. In most other environments, such as enterprise and data center locations, UTP cabling systems provide sufficient electromagnetic immunity for BASE-T networks.

Regulatory requirements for radiated emissions are also satisfied by UTP cabling systems in these environments.

With proper termination of the shielded cable throughout the channel, the shield provides a low impedance path to ground for any noise induced from external sources of EMI. In addition to providing excellent electromagnetic immunity, a properly shielded cabling system will prevent unwanted emissions radiating from the cable into the surrounding environment. BASE-T communication systems are designed to be balanced in nature, transmitting differential signals over twisted pairs of conductors. Due to manufacturing tolerances and practical limitations, no system is perfectly balanced and some level of common mode energy will be present throughout the cabling channel. The properly terminated shield provides a low impedance return path for this common mode energy.

While shielded systems do have these advantages, they tend to be more expensive to deploy and present installation risks when improperly grounded or terminated. Poor or improper shield terminations destroy the low impedance path from the shield to ground which is the key to providing the level of EMC performance needed in harsh environments. A poor termination can cause the shield to only be effective at very low frequencies and provide degraded protection against higher frequency interference. The worst-case scenario would occur when the shield is completely unterminated and there is no path to ground for any EMI induced current on the shield. With poor or missing shield terminations, the currents induced on the shield from EMI will introduce additional noise into the cabling system that can negatively impact communication across the network. Under these conditions, the degraded EMC performance of a shielded cabling system can be worse than a UTP cabling system.

Creating Impedance Discontinuities

Building an unshielded channel with unshielded plugs, unshielded connectors, and a cable which incorporates a continuous metallic outer foil essentially creates the worst-case scenario for shielded systems described on page 6. While networks can operate successfully with UTP cabling systems in the EMC environments found in enterprise and data center locations, implementing an unterminated shielded cabling system in those environments introduces new EMC weaknesses that can disrupt communication over the network. In the presence of EMI, current can be induced in the metallic foil surrounding the cable. Unlike the shielded systems where this current is shunted to ground due to the low impedance continuity of the shield throughout the channel, the induced current will be reflected at each UTP connector and/or plug interface where the continuity of the shield ends. Reflections will also occur at locations along the length of the cable where the common mode impedance of the unterminated shield changes. Metallic surfaces in close proximity to the cable will lower the impedance at these locations. Examples of these metallic surfaces are ladder racks, HVAC ducting, conduit, and structural beams as shown in Figure 3. These impedance changes will cause a portion of the induced current to be reflected at the location of the discontinuity.

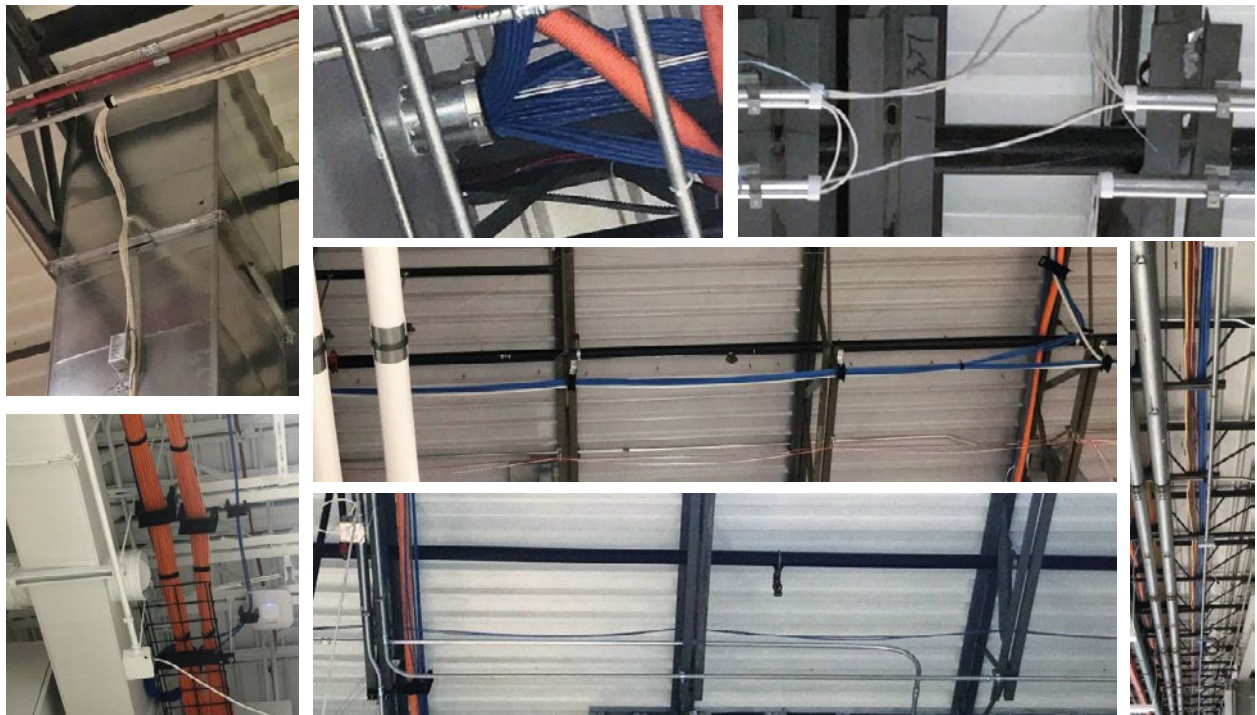

Figure 3. Example of metallic surfaces that can create impedance discontinuities.

Standing Waves

A standing wave can be built up by the current reflecting back and forth between at least two of these discontinuities. Like a dipole antenna, the combination of the successive reflections caused by the shield discontinuities will give rise to a standing wave at a frequency whose half wavelength is equal to the distance between the discontinuities. Figure 4 and Figure 5 highlight examples of where the impedance discontinuities and multiple reflections can occur. Nearby metallic surfaces such as equipment racks and cabinets can also act as a reference plane for the current induced on the metallic foil serving to enhance the resonant behavior of the unterminated foil. This standing wave on the unterminated foil will occur when the EMI incident on the cable is at or close to the aforementioned frequency. As a result, the unterminated shield can have voltage maxima and minima along the length of the foil between successive discontinuities. A corresponding noise voltage will be induced onto the conductors within the cable at the standing wave frequency due to the strong capacitive coupling between the foil and the conductors. Imbalances in the cabling channel will convert a portion of this noise into a differential signal, while the remaining noise will remain as a common mode signal. This mechanism by which noise couples into the cabling channel from a source of EMI is unique to those cables implementing unterminated foil barriers. Traditional UTP cabling channels will not be susceptible to this phenomenon in the same way because there is no unterminated conductor to support a standing wave.



Figure 4. Impedance discontinuities creating a standing wave, example 1.

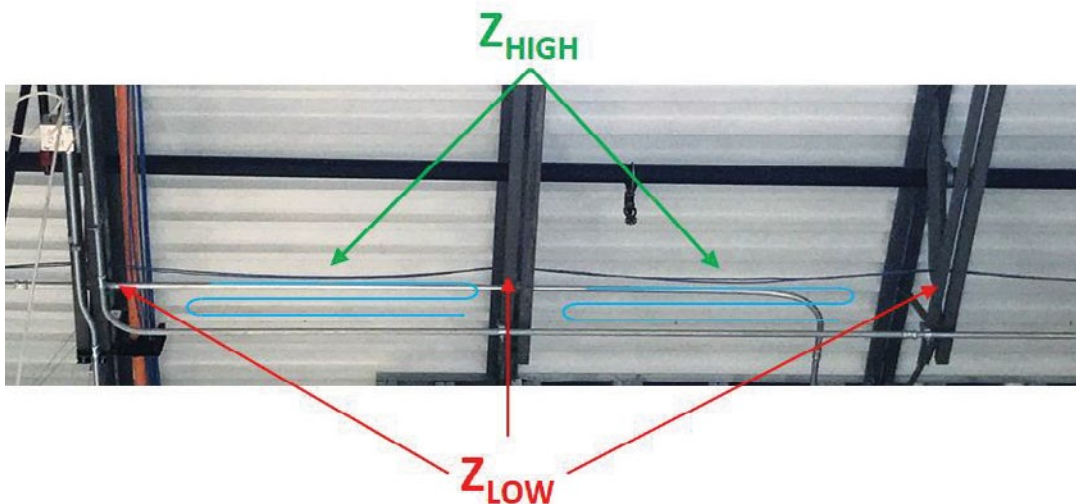

Figure 5. Impedance discontinuities creating a standing wave, example 2.



Solving the Standing Wave Problem

Panduit's Category 6A Vari-MaTriX cable is also not susceptible to this EMC phenomenon. By incorporating discontinuities into the metallic foil at short random intervals, the associated segments between discontinuities will be proportional to wavelengths of frequencies higher than the bandwidth of operation. While such a cable design may still be susceptible to interference due to standing waves at higher out-of-band frequencies, BASE-T receivers are designed with filtering on the data inputs to prevent out-of-band noise from affecting communication. In addition, the variable lengths of the discontinuous foil segments ensure that each segment will be proportional to a different out-of-band wavelength thereby minimizing any coherent interaction between the cable and an external source of interference at one particular out-of-band frequency. By preventing the possibility of standing waves to be induced within the bandwidth of operation, the Vari-MaTriX cable will behave the same as traditional UTP cable with respect to EMI. In enterprise and data center applications, Panduit's Vari-MaTriX cable will provide EMC performance equivalent to traditional UTP cable. It provides this EMC performance with superior alien crosstalk and the industry's smallest cable diameter.

There are many variables that determine whether a network will be impacted by this EMC phenomenon. Many of these variables are impossible to predict or control. These variables include:

- The orientation of the cable relative to the polarization of the EMI. When the E-field from the interfering signal is aligned with the orientation of the cable, the induced current on the metallic foil will be maximized.
- The location along the channel where the interference occurs also plays an important role. Interference that occurs near the ends of a channel will not have far to travel before reaching the receiver, therefore will not be attenuated significantly by the insertion loss of the cable.
- The length of the channel exposed to EMI will also factor into the overall impact. While a certain level of interference may disrupt communication over long channels, that same level of EMI may not cause any disruption over shorter channels as they will have an inherently higher signal-to-noise ratio (SNR) and be more tolerant of additional noise.

Each cabling installation is unique, and the nature of EMI can be both dynamic and unpredictable. While all unshielded cable types can be susceptible to EMI, the difference is that unshielded cables with an unterminated foil creates the risk of exacerbated susceptibility and emissions due to the standing waves that can be induced on the unterminated foil. The Panduit Vari-MaTriX cable does not have this risk.

Test Setup & Results

To see the electromagnetic susceptibility impact of unterminated foil barriers, a test setup was constructed to demonstrate the effect of EMI on 10GBASE-T communication. The channel was constructed with four connectors and a total channel length of 40m which is representative of many real-world cabling installations. With only 40m of attenuation through the channel, a reasonably high signal to noise ratio (SNR) at each end of the link is ensured. Internal noise sources due to crosstalk and echo will be small compared to the signal strength at the receivers. Starting from this robust baseline operating condition, the addition of EMI induced noise will be the dominant influence on 10GBASE-T communication. To accurately compare the susceptibility performance of different cable constructions, it is important that the influence of susceptibility be the dominant source of noise impacting data communication during the test.

The test was configured to emulate one possible real-world application environment. Per Figure 6, an IXIA 10GBASE-T line card (LSM10GXM2GBT-01) was used to generate and monitor the 10GBASE-T traffic bidirectionally across the channel. One port of the IXIA traffic generator was connected to a shielded port on the equipment rack inside the anechoic chamber through shielded cabling. All shield connections from the IXIA box to the equipment rack in the anechoic chamber were continuous and properly terminated with best practices. This connection serves to bring the data source (IXIA) to the equipment rack without having to position the IXIA physically inside the anechoic chamber where it would be exposed to the EMI. The portion of the channel under test being exposed to EMI was then connected to the equipment rack.

The test was conducted by comparing the performance of 1m horizontal cables terminated with unshielded plugs (similar to a patch cord). In each scenario, the cable type was changed to be the types under evaluation (UTP cable with no foil, solid foil, and Vari-MaTriX cable). These devices under test (DUT) were connected to a UTP jack and 10m of UTP horizontal cable which was routed back out of the anechoic chamber. A 2m UTP patch cord completed the connection from the horizontal cable to the second port on the IXIA traffic generator as shown in Figure 6. The specific DUTs are:

- DUT1: 1m true UTP patch cord
- DUT2: 1m patch cord made with a floating unterminated foil around the conductors. In this configuration, there is a 1m length between shield discontinuities.
- DUT3: 1m patch cord made with the Vari-MaTriX cable which uses a metallic foil barrier with variable length discontinuities in the foil.

Using a signal generator, power amplifier, and log periodic antenna, the frequency and field strength of the EMI can be accurately controlled. Conducting the test in a fully anechoic chamber allows the polarization of the interfering signal to be controlled relative to the position of the cable under test. This is a key variable associated with EMI and impossible to predict in every real-world environment. The worst-case scenario arises when the electric field of the interfering wave is aligned with the position of the cable as the induced current in the cable will be maximized. During this experiment, the cable under test was positioned horizontally across a table to align with the horizontal polarization of the log periodic antenna. The fully populated equipment rack creates a metallic surface which will act as a reference plane for the current induced on the cable under test. The position and orientation of the DUTs exposed to the EMI and all other channel components was identical when testing DUT1, DUT2, and DUT3 to ensure an accurate comparison between the test conditions.

Test Setup & Results (continued)

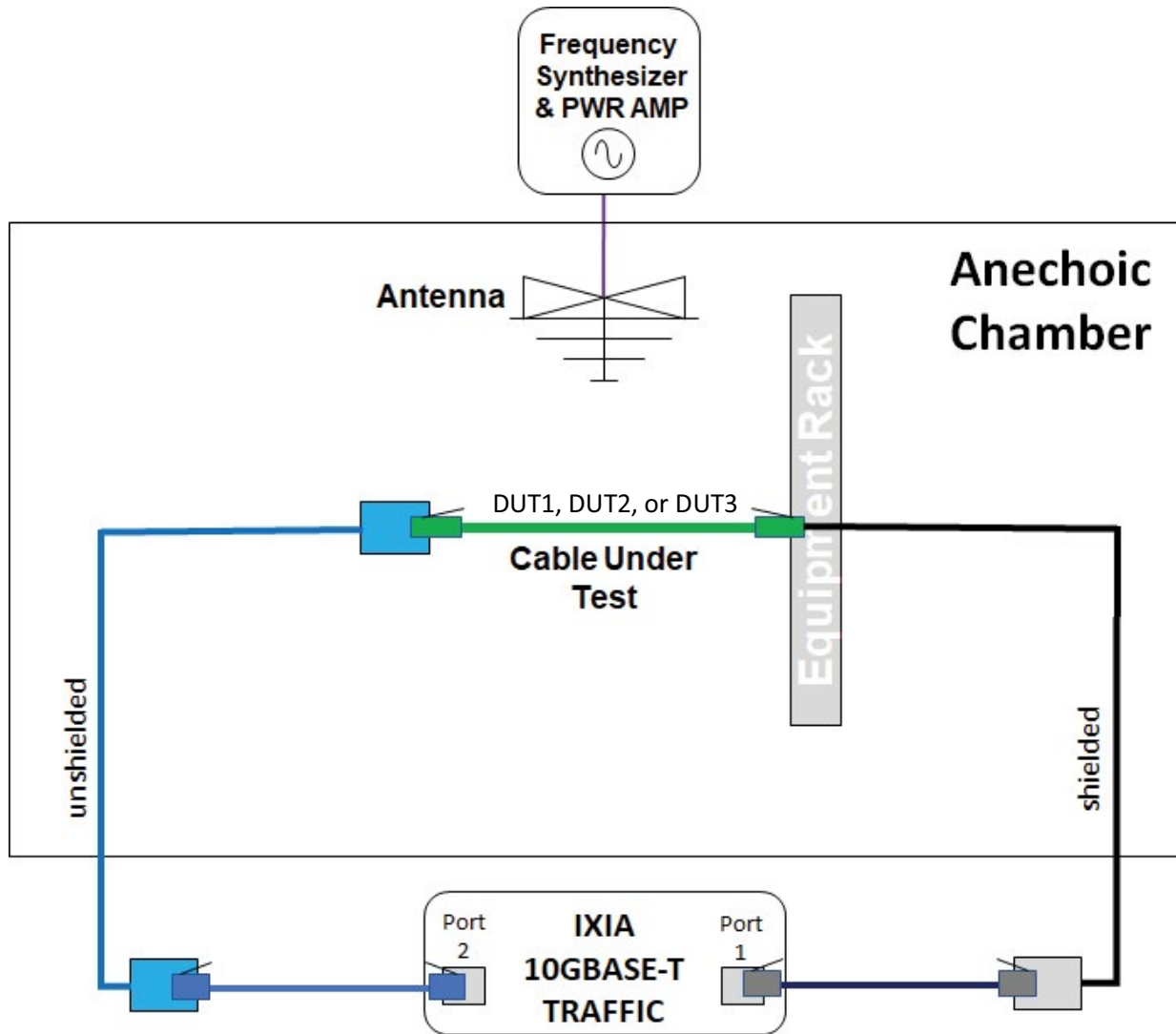

Figure 6. Test setup used for evaluating solid foil and Vari-MaTriX cable.

With 10GBASE-T traffic running bidirectionally across the channel, the frequency was swept from 101 MHz to 131 MHz in 2 MHz intervals. At each frequency point, the field strength of the EMI was increased until the onset of packet errors was captured by the IXIA traffic tester. The field strength was then increased further until the interference was strong enough to cause the link to drop, interrupting all 10GBASE-T communication. The power levels at both “packet error onset” and “link drop” were recorded at each frequency for all three DUTs.

Impact of Packet Errors

In a live network, the impact of packet errors can be seriously disruptive. Any errored packets on a TCP/IP Ethernet link will be dropped by the receiving system and subsequently must be retransmitted from the source. Depending on network factors such as packet size, buffer size, and round-trip time, even a modest loss of packets (1 out of 10,000) can cause throughput to drop by up to 90%. This could lead to sluggish or even unusable conditions for the applications relying on an Ethernet link. The consequences of a complete link drop can be even more problematic, as the entire Ethernet connection will have to go through the auto-negotiation sequence to reestablish communication across the link. Many applications will not be able to survive this type of event.

A comparison of the electromagnetic susceptibility between the three DUTs is plotted in Figure 7 and Figure 8 below. Figure 7 shows the EMC degradation at the onset of packet errors compared to traditional UTP cable for both floating shield and Vari-MaTriX cable construction. The maximum degradation of slightly more than 5dB was observed at approximately 105 MHz with DUT2 (Floating Shield). The half wavelength of a signal propagating on a cable at 105 MHz is approximately 1m. This is the exact length between discontinuities in the floating shield. Due to the standing wave induced on the floating shield by interference at 105 MHz, the susceptibility of the 10GBASE-T link was 5dB worse than the traditional UTP cable. Figure 8 shows the EMC degradation at link drop compared to traditional UTP cable for both floating shield and Vari-MaTriX cable construction. Again, at approximately 105 MHz the worst-case degradation of 6dB was observed with DUT2 (Floating Shield), demonstrating that unterminated foil degrades the susceptibility of the channel compared to traditional UTP. A 6dB degradation equates to a reduction in electromagnetic immunity by a factor of 2. In comparison, there was no EMC degradation with Vari-Matrix cable for either the onset of packet errors or the link drop condition.

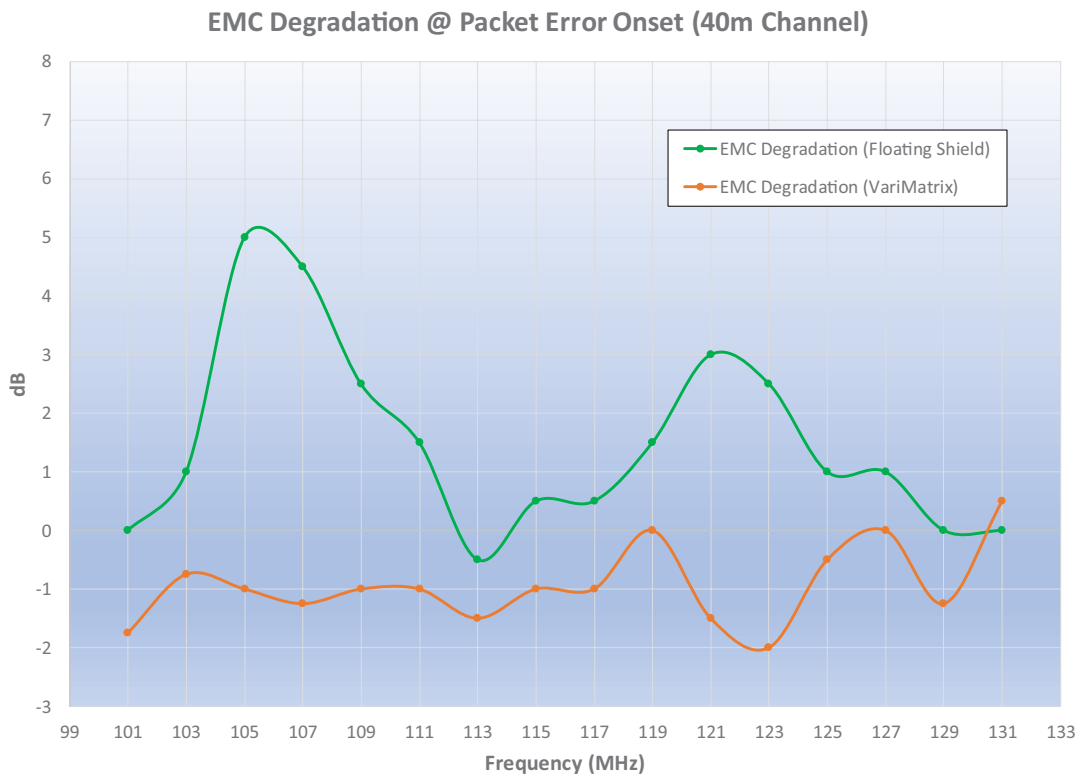

Figure 7. Floating Shielded vs Vari-MaTriX EMC Degradation at Error Onset, Device Under Test at 1m.

Impact of Packet Errors (continued)

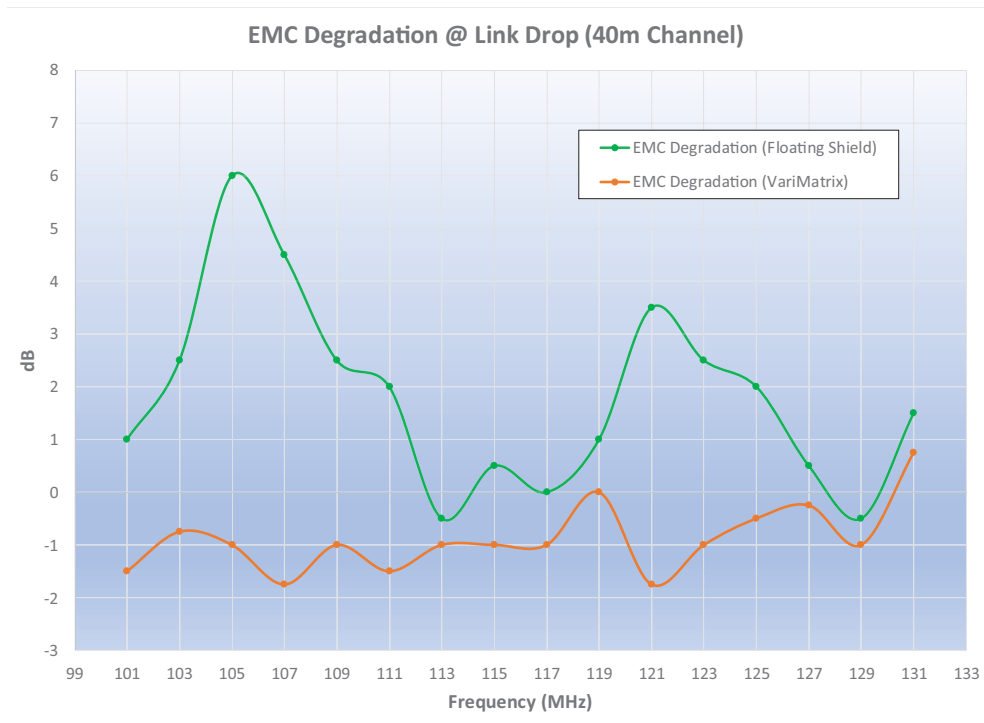

Figure 8. Floating Shielded vs Vari-MaTriX EMC Degradation at Link Drop, Device Under Test at 1 m.

To translate this factor of 2 to a real-world example as shown in Figure 9, consider a source of EMI at 105 MHz, such as FM radio broadcast, that produces a safe level of EMI in a data center when it is located at least two miles away and Vari-MaTriX cabling channels are installed. If cabling with unterminated continuous foil barriers were installed, the safe distance to the FM broadcast tower would now be at least four miles (2X) away. The “safe” distance implies that even when all the variables involved with susceptibility align in the worst-case fashion, the network will not be affected by the interfering noise.

Impact of Packet Errors (continued)

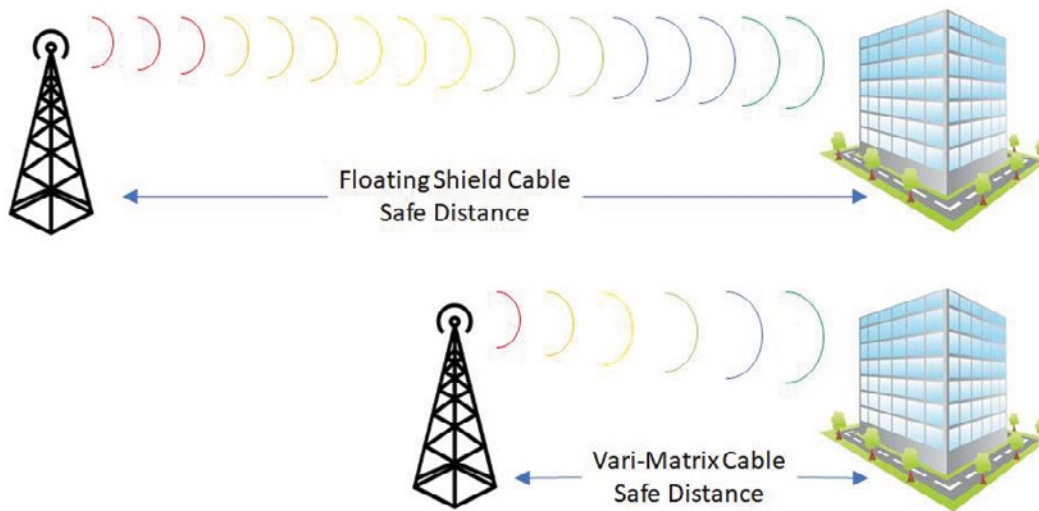

Figure 9. Vari-MaTriX EMC safe distance from EMI source reduced by 2X.

To further validate this phenomenon, another test was done with shorter DUTs of approximately 0.5m. With 10GBASE-T traffic running bidirectionally across the channel, the frequency was swept from 198 MHz to 228 MHz in 2 MHz intervals. At each frequency point, the field strength of the EMI was increased until the onset of packet errors was captured by the IXIA traffic tester. The field strength was then increased further until the interference was strong enough to cause the link to drop, interrupting all 10GBASE-T communication. The power levels at both “packet error onset” and “link drop” were recorded at each frequency for all three DUTs.

A comparison of the electromagnetic susceptibility between the three DUTs is plotted in Figure 10 and Figure 11. Figure 10 shows the EMC degradation at the onset of packet errors compared to traditional UTP cable for both floating shield and Vari-Matrix cable construction. The maximum degradation of 8.5dB was observed at approximately 220 MHz with DUT2 (Floating Shield). The half wavelength of a signal propagating on a cable at 220 MHz is approximately 1m. This is the exact length between discontinuities in the floating shield. Due to the standing wave induced on the floating shield by interference at 220 MHz, the susceptibility of the 10GBASE-T link was 8.5dB worse than the traditional UTP cable. Figure 11 shows the EMC degradation at link drop compared to traditional UTP cable for both floating shield and Vari-Matrix cable construction. Again, at approximately 220 MHz the worst-case degradation of 9.5dB was observed with DUT2 (Floating Shield), demonstrating that unterminated foil degrades the susceptibility of the channel compared to traditional UTP. A 9.5dB degradation equates to a reduction in electromagnetic immunity by a factor of 3. In comparison, there was no EMC degradation with Vari-MaTriX cable for either the onset of packet errors or the link drop condition. Just as in the previous example, this factor of 3 requires that the safe distance from an EMI source at 220 MHz is three times further when cables with unterminated continuous foil barriers are used compared to Vari-MaTriX cable or traditional UTP cable.

Test Setup & Results

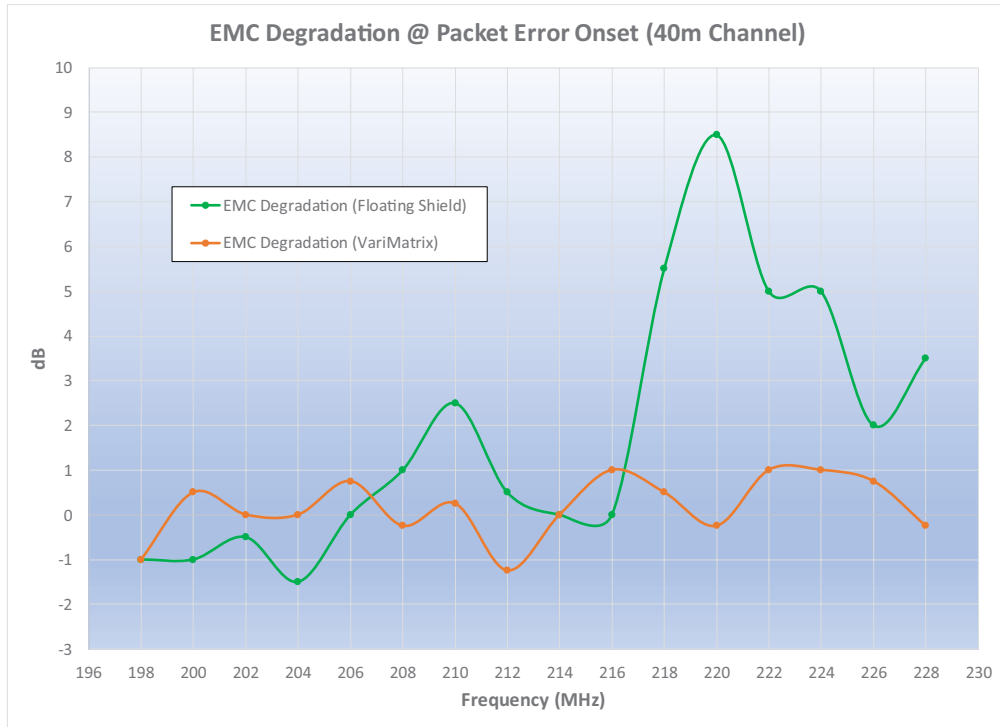

Figure 10. Floating Shielded vs Vari-MaTriX EMC Degradation at Error Onset, Device Under Test at 0.5m.

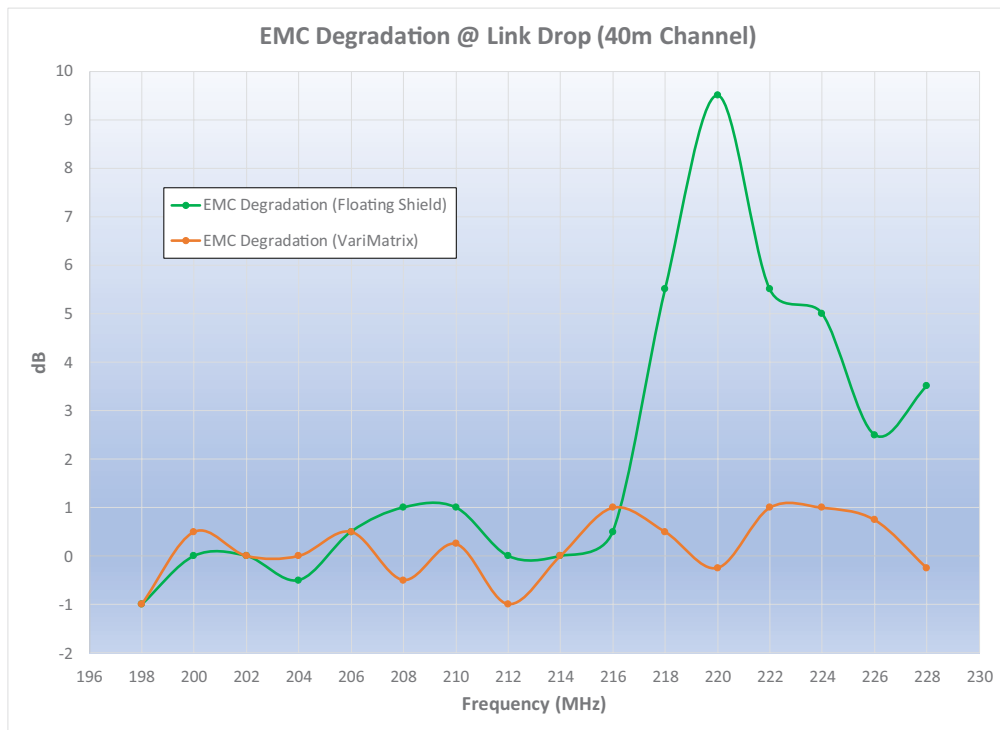

Figure 11. Floating Shielded vs Vari-MaTriX EMC Degradation at Link Drop, Device Under Test at 0.5m.

Industry Perspective

The EMC impact of unterminated or floating shields has been investigated and documented by others in the past as well. One example can be found in a January 2006 contribution to the IEEE 802.3an standards titled “Using ScTP Patch Cords for Mitigating Alien Crosstalk.” This contribution documented how floating patch cord shields in a UTP channel caused increased radiated emissions compared to traditional UTP patch cords. Increased radiated emissions may cause network equipment to fail FCC compliance testing.

Reports and marketing materials have been published within the industry claiming that floating shields on cables pose no risk of degrading the EMC performance of a network. Some reports go so far as to claim that floating cable shields improve the EMC performance of a network. These reports sometimes reference testing done in anechoic chambers related to either radiated emissions or radiated susceptibility. When the specific details of those tests are studied, it is clear that one or more of the important variables involved in the configuration of the test prevents the impact of the unterminated shield from being observed. Instances where this can occur would be:

- When the frequency of the interfering signal is not correlated with the distance between floating shield discontinuities, no measurable difference between UTP cable and floating shield cable will be observed.
- If the orientation of the cable under test is not in alignment with the polarization of the EMI, there will be no discernable difference compared to traditional UTP cable.
- Some reports test the immunity of the cable without any mechanism for mode conversion, such as connectors, which is the primary means by which the interference is converted to differential noise.
- Others have tested the entire cable suspended in air with no nearby structure to act as a reference plane thereby hiding the cables true potential to behave as an antenna.
- Some cables have been tested in a manner not applicable to BASE-T communication. For example, connecting only one pair of the cable to a transmitter while the other three pairs are terminated in matched loads at both ends of the cable.

The results of these tests are not surprising or fundamentally wrong. In fact, they corroborate the unique alignment of factors that are required to cause degraded EMC performance. They are incorrect when broadly claiming that unterminated shields will never degrade the EMC characteristics of a cable. While unterminated shields will not always result in degraded EMC performance, they do introduce the unnecessary risk for potential EMC problems.



Conclusion

While there are many factors that can impact the immunity performance of a cabling system in real-world installations, Panduit's Vari-MaTriX cable demonstrates that it is not influenced by factors such as a cable with a solid foil, and subsequently provides better electromagnetic immunity performance. Improved immunity performance means that the Vari-MaTriX cable can be placed closer to noise sources, and has a lower risk of throughput reduction.

Although this paper focuses on the immunity of the cable to external noise sources, a cable that is susceptible at certain frequencies will also radiate noise at those same frequencies due to the reciprocal relationship between emissions and susceptibility. The impact of increased electromagnetic radiation due to unterminated shields can cause a system to violate federal and international requirements outlined in FCC Part 15 and CISPR 32. In a real-world application, this can mean interfering with and disrupting normal operation of any nearby electronic devices such as wireless access points, video surveillance cameras, building automation hardware, and other monitoring devices commonly found in enterprise and data center facilities.

The impact of the unterminated foil barriers on the electromagnetic immunity of a cable can affect 10GBASE-T communication compared to Vari-MaTriX cable and traditional UTP cable. The measurements reveal that cables with unterminated foil barriers can degrade the EMC performance of a system by a factor of 3. In a live network connected by cabling with floating shields, the heightened sensitivity to EMI can translate to higher rates of packet errors and dropped links leading to severe throughput limitations.

Panduit's Vari-MaTriX cable, with a 0.250" (6.4mm, plenum) to 0.260" (6.6mm, low smoke) diameter, avoids this unnecessary EMC risk while still providing superior alien crosstalk suppression and the best EMC performance when compared to other cables that are using solid foils. Panduit recommends using the Category 6A Vari-MaTriX cable for your next installation running 10GBASE-T to ensure optimal network performance.

Referenced Standards

IEEE Std. 802.3an. "Using SCTP Patch Cords for Mitigating Alien Crosstalk." 2006.

Federal Communications Commission. FCC Part 15. "Radio Frequency Devices." 2018.

CISPR 32. "Electromagnetic compatibility of multimedia equipment – Emission requirements." 2015.



Since 1955, Panduit's culture of curiosity and passion for problem solving have enabled more meaningful connections between companies' business goals and their marketplace success. Panduit creates leading-edge physical, electrical, and network infrastructure solutions for enterprise-wide environments, from the data center to the telecom room, from the desktop to the plant floor. Headquartered in Tinley Park, IL, USA and operating in 112 global locations, Panduit's proven reputation for quality and technology leadership, coupled with a robust partner ecosystem, help support, sustain, and empower business growth in a connected world.

For more information

Visit us at www.panduit.com

**Contact Panduit North America Customer Service by email: cs@panduit.com
or by phone: 800.777.3300**

THE INFORMATION CONTAINED IN THIS WHITE PAPER IS INTENDED AS A GUIDE FOR USE BY PERSONS HAVING TECHNICAL SKILL AT THEIR OWN DISCRETION AND RISK. BEFORE USING ANY PANDUIT PRODUCT, THE BUYER MUST DETERMINE THE SUITABILITY OF THE PRODUCT FOR HIS/HER INTENDED USE AND BUYER ASSUMES ALL RISK AND LIABILITY WHATSOEVER IN CONNECTION THEREWITH. PANDUIT DISCLAIMS ANY LIABILITY ARISING FROM ANY INFORMATION CONTAINED HEREIN OR FOR ABSENCE OF THE SAME.

All Panduit products are subject to the terms, conditions, and limitations of its then current Limited Product Warranty, which can be found at www.panduit.com/warranty.

PANDUIT US/CANADA
Phone: 800.777.3300

PANDUIT EUROPE LTD.
London, UK
cs-emea@panduit.com
Phone: 44.20.8601.7200

PANDUIT SINGAPORE PTE. LTD.
Republic of Singapore
cs-ap@panduit.com
Phone: 65.6305.7575

PANDUIT JAPAN
Tokyo, Japan
cs-japan@panduit.com
Phone: 81.3.6863.6000

PANDUIT LATIN AMERICA
Guadalajara, Mexico
cs-la@panduit.com
Phone: 52.33.3777.6000

PANDUIT AUSTRALIA PTY. LTD.
Victoria, Australia
cs-aus@panduit.com
Phone: 61.3.9794.9020