

CFG1**

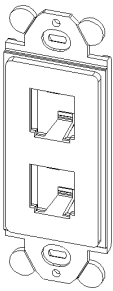

CFG2**

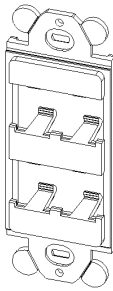

CFG4**

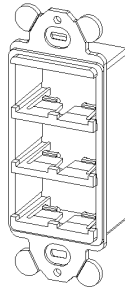

CFG6**^

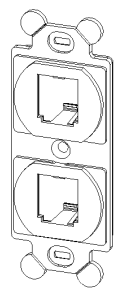

CF1062**Y

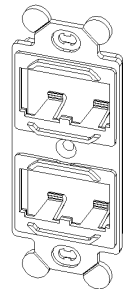

CF1064**Y

INSTALLATION

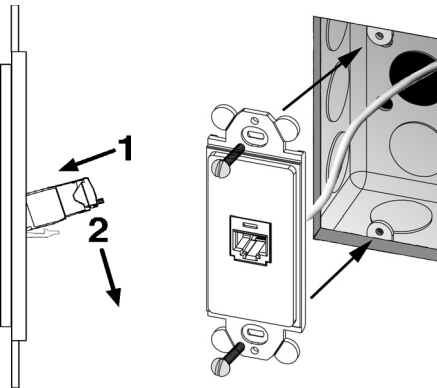

REMOVAL

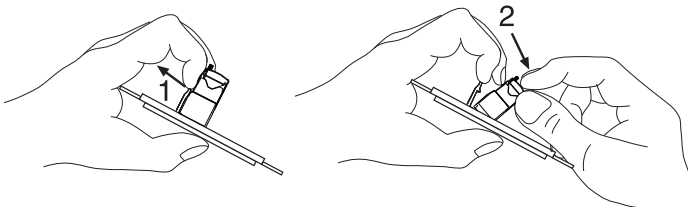

** Denotes color

^ Denotes limited to unshielded installations