

## ***Troubleshooting a Permanent Link***

### **Introduction**

Troubleshooting fiber optic permanent links in the field can become very tedious, time consuming and frustrating if some simple steps are not followed. The following document will suggest steps to follow in order to systematically test and troubleshoot a permanent link consisting of MPO horizontal cabling and LC to MPO cassettes during installation.

### **Testing/Troubleshooting a Cassette to Cassette based system**

**Apply the following when testing/troubleshooting a Cassette to Cassette based system.**

1. Reference utilizing method B (One Jumper Reference)

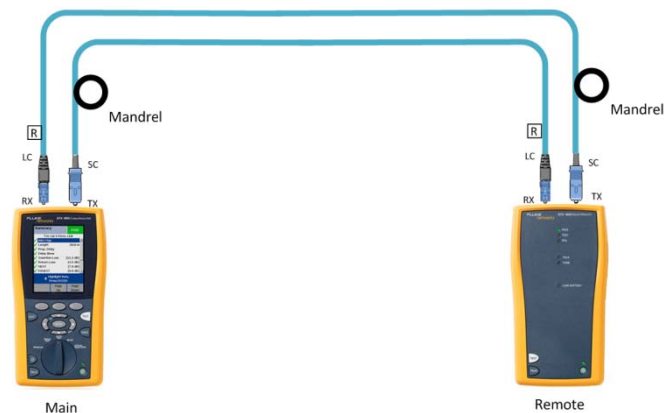

2. After referencing (Results between -22dB and -24dB). Add LC to LC reference cords and test them to ensure they are within the 0.15dB standard for IL.

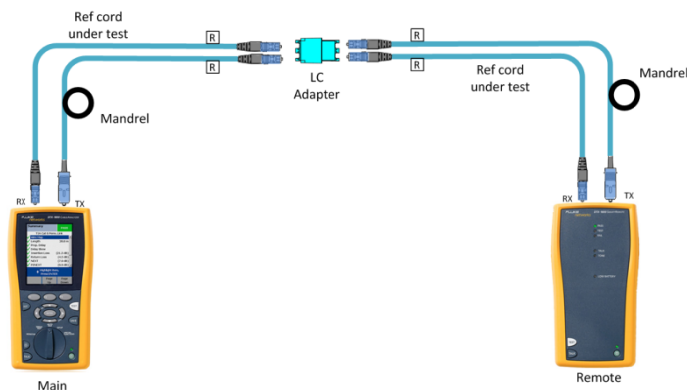

### 3. Test Link

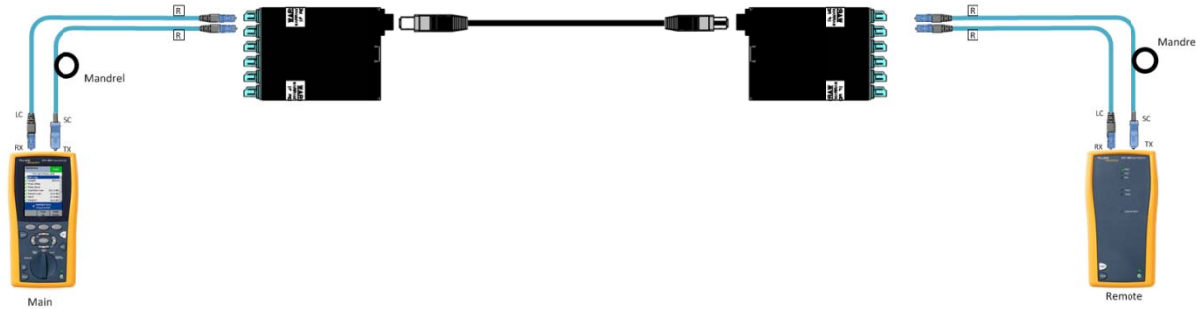

4. If link fails, inspect the LC endfaces of the reference cords that are mated to the cassettes, dry clean if necessary, re-inspect. Re-mate when clean and retest the link.

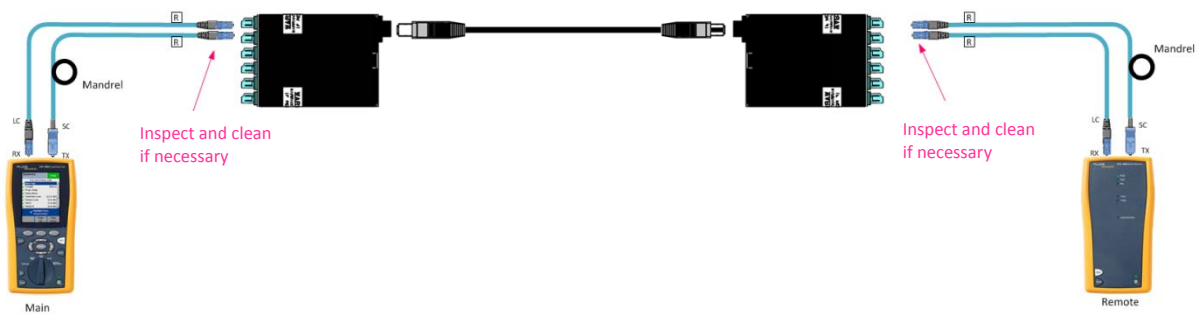

5. If the link fails, inspect the MPO endfaces of the trunk assembly attached to the cassettes and the endfaces of the MPO internal to the cassette. Dry clean if necessary, re-inspect and re-mate when clean. Retest the link.

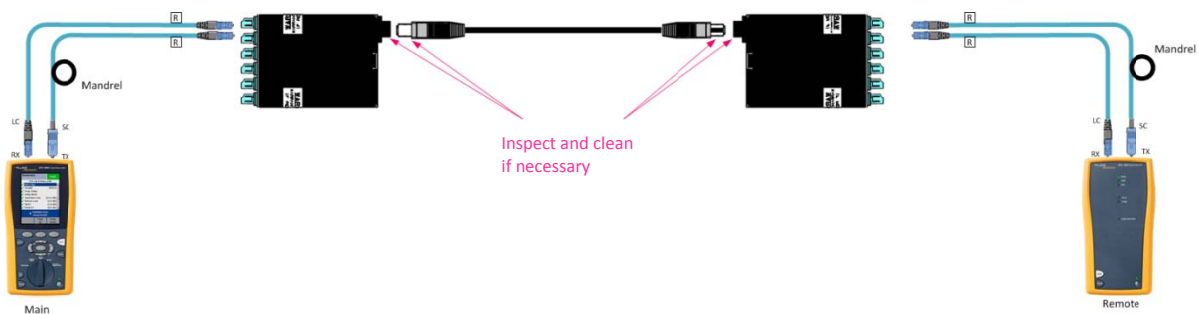

6. If the link fails, inspect the LC endfaces internal to the cassettes and re-inspect the endfaces of LC reference cords mated to the cassettes. Dry clean if necessary, re-inspect, re-mate when clean and retest the link.

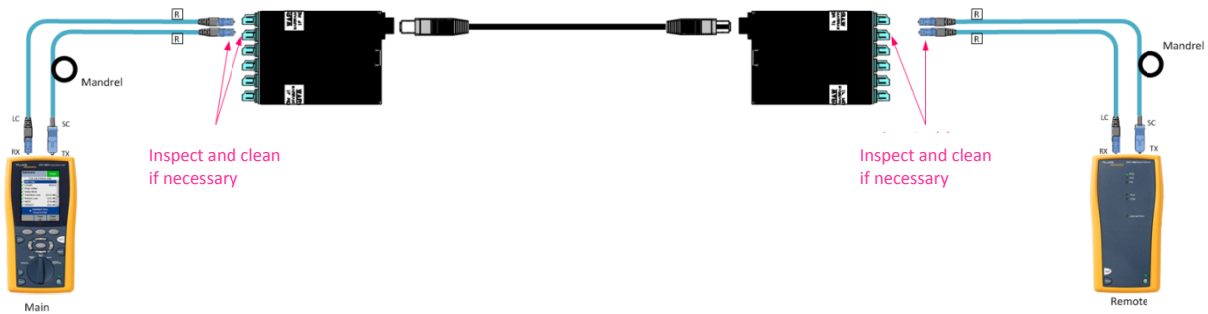

7. If the link fails, swap cassettes. If and retest.

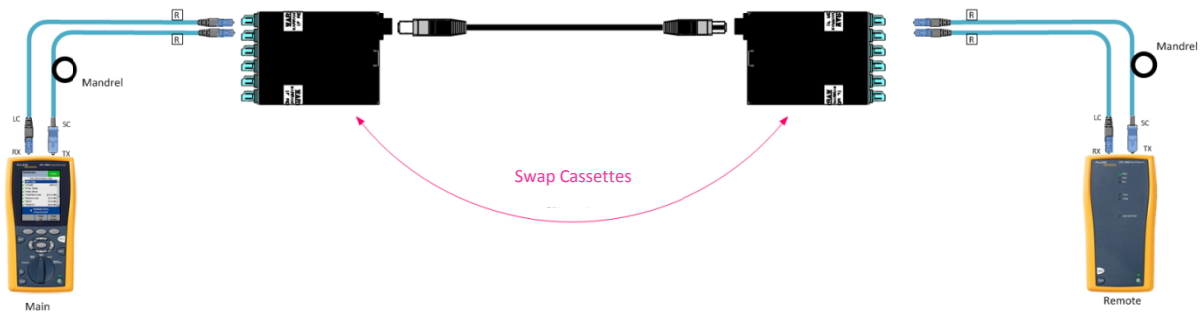

8. If the failure follows the cassette, then you know the cassette is bad. If it doesn't then there is possibly something wrong with the MPO on the failed side of the link.
9. Either try a new cassette to ensure the endface mating between the cassette MPO and the horizontal cabling MPO was not the issue or you can try testing the MPO cabling solution with the Multi-Fiber Pro

**Testing the Horizontal using Multi-Fiber Pro (with PanMPO reference cords)**

**Apply the following when testing an MPO horizontal cabling infrastructure.**

1. Reference utilizing Method B. (Note: The PanMPO will need to have male gender to interface with the Fluke Multi-Pro female interface).



Setting  
Reference

2. Test the MPO reference cord. This is completed by changing the one PanMPO reference cord end to female gender as shown.

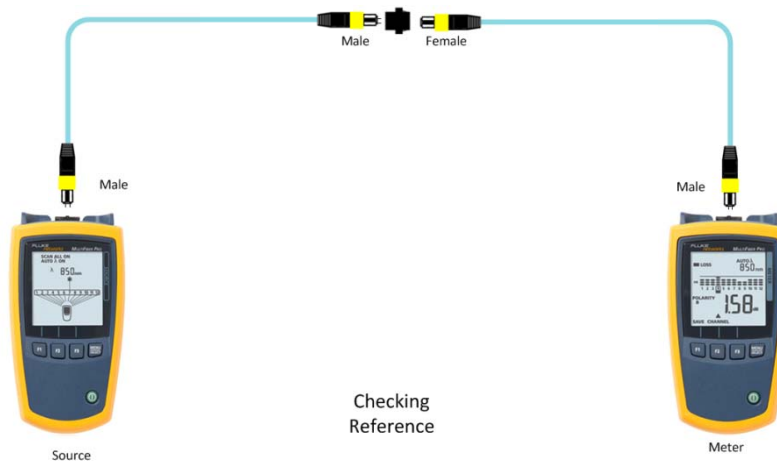

Checking  
Reference

**Note: The reference value for all twelve channels shall be  $\geq 0.25\text{dB}$  to ensure the MPO cable meets reference grade specifications.**

3. Test MPO horizontal cable as shown. Note that the Female PanMPO used in Step 2 to check the integrity of the reference cord has to be changed back to Male in order to test the link.

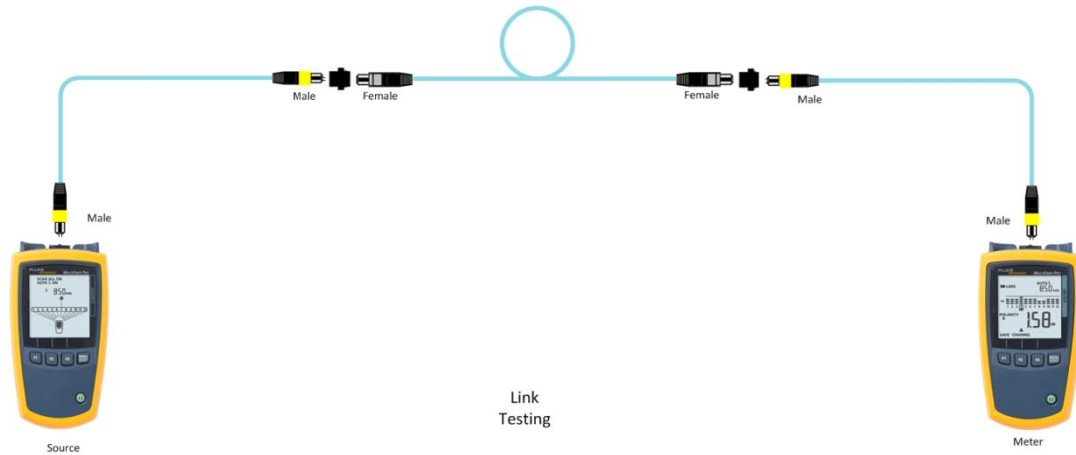

4. If the link fails, inspect all four endfaces and clean if necessary. Re-mate and retest.

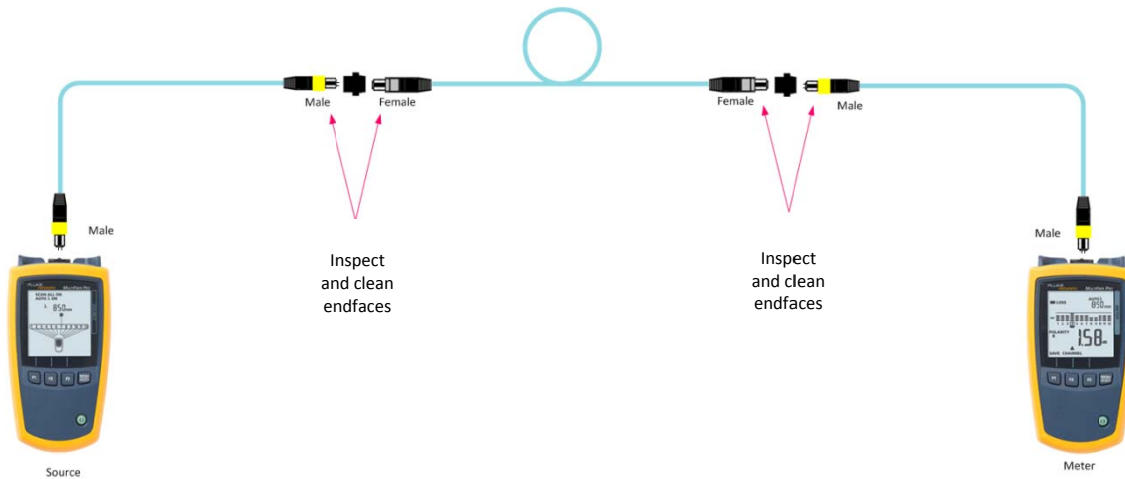

5. If the link fails, flip the Meter and Source and test from the other direction.

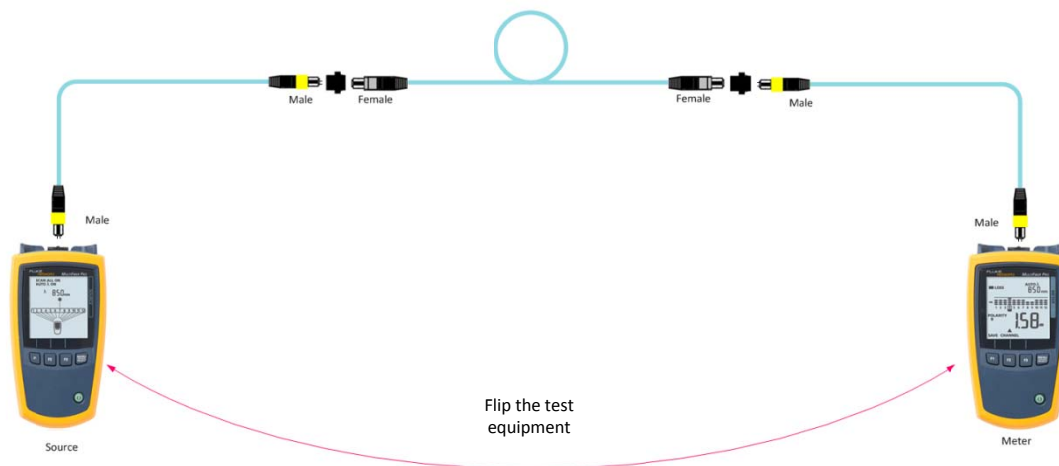

6. If the link fails, then there is an issue with either the MPO connector on the assembly or with the cable within the assembly. If it passes, there is an issue with the MPO connector on the first end tested and further troubleshooting needs to occur or the MPO needs to be replaced.