

Mini-Com™ Surface Mount Boxes with Quick Release Cover – Japan

specifications

Surface Mount Boxes shall have a low profile design and be available in a variety of port densities. Boxes shall accept most Mini-Com™ Modules for fiber, copper, and audio/video applications. Boxes shall include a cover with a quick release feature. The boxes shall mount with screws, adhesive, or enclosed magnets. The covers include breakouts that shall be compatible with larger cables. Cable tie slots shall be included to provide strain relief on incoming cables. Surface mount boxes shall be available as a single box without modules and as a kit with modules. Kits are available in Category 5e, Category 6 and Category 6A and include the new Mini-Com™ Shuttered Jacks.



technical information

| Ports | Performance | Part Number | Module | Magnet | No. of Cable ties | Label Pocket |
|--------|-------------|-------------|----------------------|--------|-------------------|--------------|
| 1-port | - | JOQ10000 | - | 1 | 1 | - |
| | Category 5e | JOQ1H500 | CJH5E88TGIW | | | |
| | Category 6 | JOQ1H600 | CJH688TGIW | | | |
| | Category 6A | JOQ1H6A00 | CJH6X88TGIW | | | |
| 2-port | - | JOQ20000 | - | 1 | 1 | Yes |
| | Category 5e | JOQ2H500 | CJH5E88TGIW | | | |
| | Category 6 | JOQ2H600 | CJH688TGIW | | | |
| | Category 6A | JOQ2H6A00 | CJH6X88TGIW | | | |
| 3-port | - | JOQ3B0000 | - | 2 | 2 | Yes |
| | Category 5e | JOQ3BH500 | CJH5E88TGIW w/ blank | | | |
| | Category 6 | JOQ3BH600 | CJH688TGIW w/ blank | | | |
| | Category 6A | JOQ3BH6A00 | CJH6X88TGIW w/ blank | | | |
| 4-port | - | JOQ40000 | - | 2 | 2 | Yes |
| | Category 5e | JOQ4H500 | CJH5E88TGIW | | | |
| | Category 6 | JOQ4H600 | CJH688TGIW | | | |
| | Category 6A | JOQ4H6A00 | CJH6X88TGIW | | | |
| 6-port | - | JOQ60000 | - | 2 | 2 | Yes |
| | Category 5e | JOQ6H500 | CJH5E88TGIW | | | |
| | Category 6 | JOQ6H600 | CJH688TGIW | | | |
| | Category 6A | JOQ6H6A00 | CJH6X88TGIW | | | |

Mini-Com™ Quick Release Surface

| | |
|---------|-----------|
| 1-port: | JOQ10000 |
| 2-port: | JOQ20000 |
| 3-port: | JOQ3B0000 |
| 4-port: | JOQ40000 |
| 6-port: | JOQ60000 |

Mini-Com™ Quick Release Surface Mount Box Kits (include Mini-Com™ Shuttered Jacks*‡)

| | |
|---------------|------------|
| 2-port | |
| Category 5e: | JOQ2H500 |
| Category 6: | JOQ2H600 |
| Category 6A: | JOQ2H6A00 |
| 3-port | |
| Category 5e: | JOQ3BH500 |
| Category 6: | JOQ3BH600 |
| Category 6A: | JOQ3BH6A00 |
| 4-port | |
| Category 5e: | JOQ4H500 |
| Category 6: | JOQ4H600 |
| Category 6A: | JOQ4H6A00 |
| 6-port | |
| Category 5e: | JOQ6H500 |
| Category 6: | JOQ6H600 |
| Category 6A: | JOQ6H6A00 |

* Part numbers listed in IW (Off White). Also available in BL (Black). Add suffix BL to existing part numbers. Ex: JOQ1H500BL or JOQ6H500BL

‡Number of ports determine number of jack modules in corresponding category in kits. All boxes include installed magnet.

key features and benefits

| | |
|-----------------------------|--|
| Quick cover removal: | Can be removed by hand; does not require a tool |
| Shuttered: | Built into the new shuttered jacks when kitted |
| Modular: | Accepts most Mini-Com™ modules for easy moves, adds and changes |
| Low profile design: | Smaller profile is less conspicuous |
| Cover screw: | Boxes with label pocket provide a screw that secures the cover to the base |
| Labels and covers: | Select boxes include a label pocket to meet labeling standards |
| Hidden magnet: | Smaller, stronger magnet is enclosed to protect surface |

applications

Mini Com™ Surface Mount Boxes w/ Quick Release Cover offers a variety of mounting options, allowing Mini com™ modules to be mounted on a variety of surfaces, such as standard walls, metal surfaces, office furniture, etc. Quick release surface mount boxes include breakouts compatible with Panduit LD Surface Raceway system to allow cable to enter into the box providing a point of connection for voice, video and data applications.

Quick cover removal provides easy access for moves, adds and changes with the ability to secure cover to base if needed. The enclosed magnet provides an easy mounting method. Mini Com™ blanks (CMBIW-X) can be used to reserve space for future expansion.

Mini-Com™ Surface Mount Boxes with Quick Release Cover – Japan

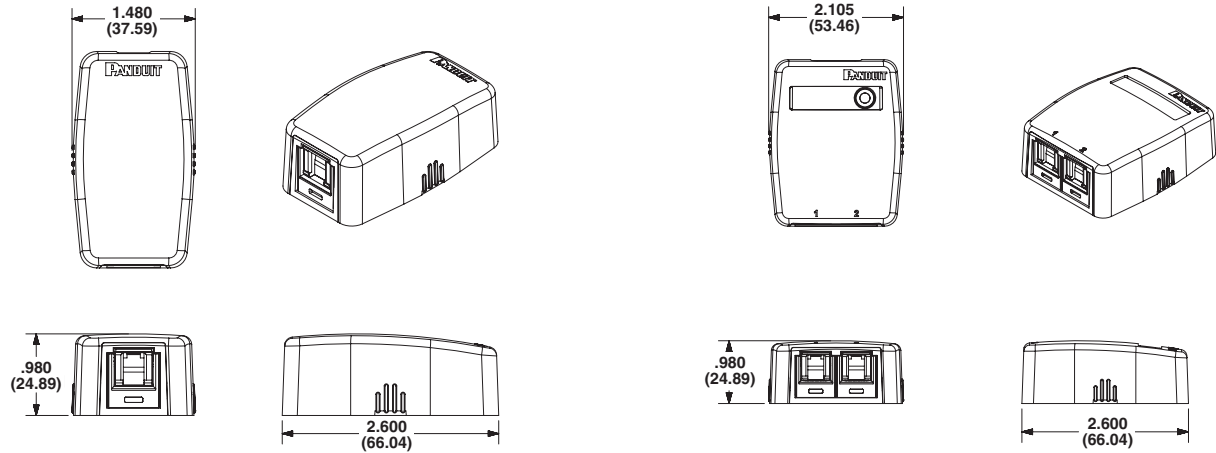

1-port, kitted with:
 Category 5e jacks: JOQ1H500, JOQ1H500BL
 Category 6 jacks: JOQ1H600, JOQ1H600BL
 Category 6A jacks: JOQ1H6A00, JOQ1H6A00BL

2-port, kitted with:
 Category 5e jacks: JOQ2H500, JOQ2H500BL
 Category 6 jacks: JOQ2H600, JOQ2H600BL
 Category 6A jacks: JOQ2H6A00, JOQ2H6A00BL

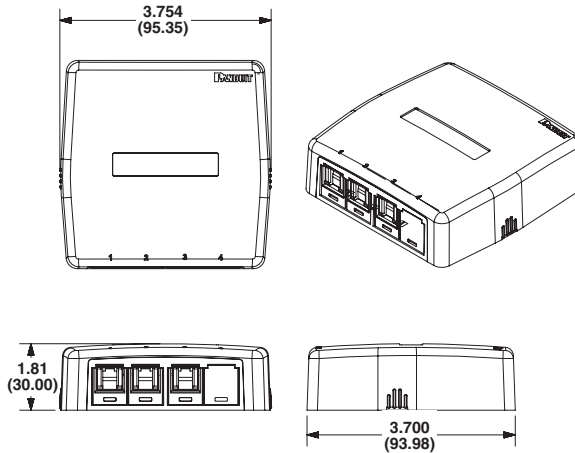

3-port, kitted with:
 Category 5e jacks: JOQ3BH500, JOQ3BH500BL
 Category 6 jacks: JOQ3BH600, JOQ3BH600BL
 Category 6A jacks: JOQ3BH6A00, JOQ3BH6A00BL

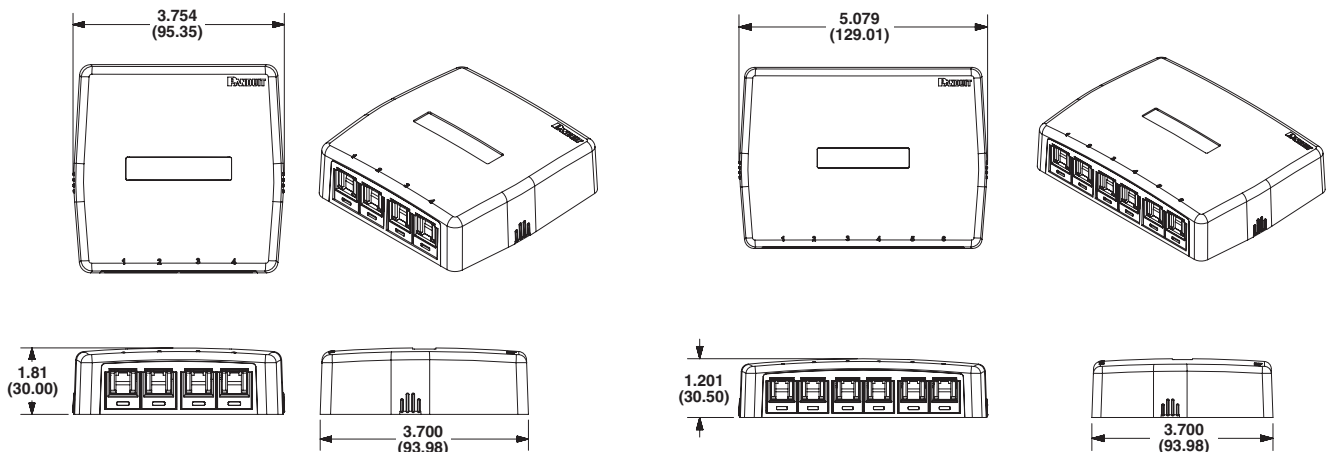

4-port, kitted with:
 Category 5e jacks: JOQ4H500, JOQ4H500BL
 Category 6 jacks: JOQ4H600, JOQ4H600BL
 Category 6A jacks: JOQ4H6A00, JOQ4H6A00BL

6-port, kitted with:
 Category 5e jacks: JOQ6H500, JOQ6H500BL
 Category 6 jacks: JOQ6H600, JOQ6H600BL
 Category 6A jacks: JOQ6H6A00, JOQ6H6A00BL

Mini-Com™ Surface Mount Boxes with Quick Release Cover – Japan

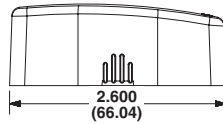
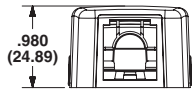
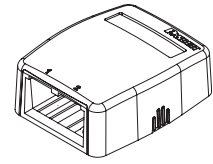
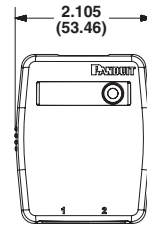
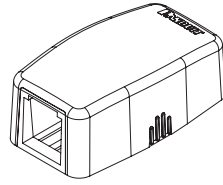
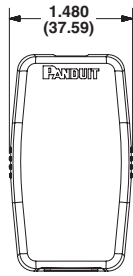

1-port, empty: JOQ10000, JOQ10000BL

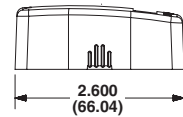
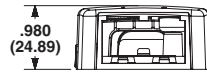

2-port, empty: JOQ20000, JOQ20000BL

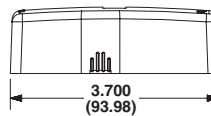
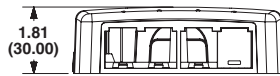
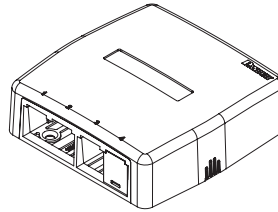
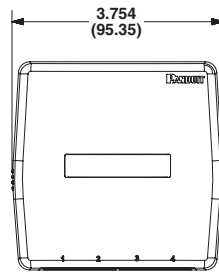

3-port, empty: JOQ3B0000, JOQ3B0000BL

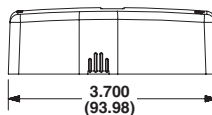
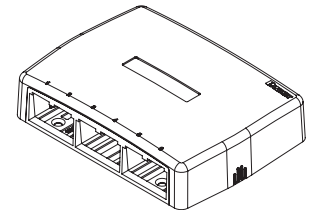
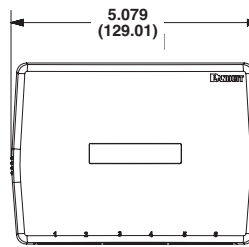
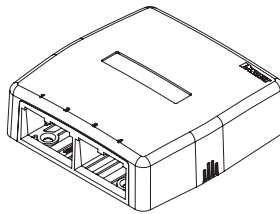
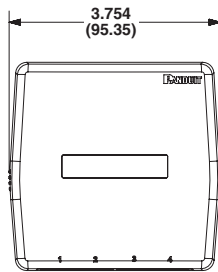

4-port, empty: JOQ40000, JOQ40000BL

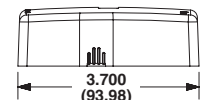

6-port, empty: JOQ60000, JOQ60000BL

Dimensions are in metric. (Dimensions in parentheses are inches).

WORLDWIDE SUBSIDIARIES AND SALES OFFICES

PANDUIT CANADA
Markham, Ontario
cs-cdn@panduit.com
Phone: 800.777.3300

PANDUIT EUROPE LTD.
London, UK
cs-emea@panduit.com
Phone: 44.20.8601.7200

PANDUIT SINGAPORE PTE. LTD.
Republic of Singapore
cs-ap@panduit.com
Phone: 65.6305.7575

PANDUIT JAPAN
Tokyo, Japan
cs-japan@panduit.com
Phone: 81.3.6863.6000

PANDUIT LATIN AMERICA
Guadalajara, Mexico
cs-la@panduit.com
Phone: 52.33.3777.6000

PANDUIT AUSTRALIA PTY. LTD.
Victoria, Australia
cs-aus@panduit.com
Phone: 61.3.9794.9020

For a copy of Panduit product warranties, log on to www.panduit.com/warranty

For more information

Visit us at www.panduit.com

Contact Customer Service by email: cs@panduit.com
or by phone: 800.777.3300

©2016 Panduit Corp.
ALL RIGHTS RESERVED.
OTSP50--WW-ENG
10/4/2016