

### AUTOMATIC CABLE TIE INSTALLATION SYSTEM OPERATION MANUAL

© Panduit Corp. 2013

Original Instructions

**This manual contains instructions for the following:**  
**PAT2S and PAT3S: Automatic Cable Tie Installation Tools**  
**PDS and PD3S: Dispensers**  
**PHS2 and PHS3: Hoses**  
**PDSF: Frame**

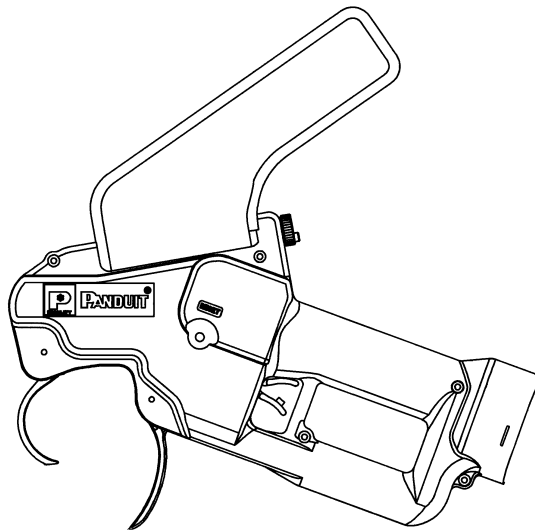

**TO REDUCE THE RISK OF INJURY, USER  
MUST READ INSTRUCTION MANUAL**

Email:  
[techsupport@panduit.com](mailto:techsupport@panduit.com)

EU Website:  
[www.panduit.com/emea](http://www.panduit.com/emea)

EU Email:  
[emeatoolservicecenter@panduit.com](mailto:emeatoolservicecenter@panduit.com)

**PANDUIT**  
[www.panduit.com](http://www.panduit.com)

Technical Support:  
Tel: 888-506-5400, ext. 83255

Panduit Europe • EMEA Service Center  
Almelo, Netherlands  
Tel: +31 546 580 452 • Fax: +31 546 580 441

Technical Support:  
[www.panduit.com/resources/install\\_maintain.asp](http://www.panduit.com/resources/install_maintain.asp)

**DECLARATION OF CONFORMITY:**



**EC Declaration of Conformity**

The undersigned representing the following supplier:

Panduit Corp  
World Headquarters  
18900 Panduit Drive  
Tinley Park, IL 60487  
USA



Herewith declare under our sole responsibility:

**Our product(s):** Cable Tie Equipment

**Product identification:** Models: PAT2S, PAT3S, PDS, PD3S

**These products are in conformity with the provisions of the following EC directives when used accordance with the instructions contained in the product documentation.**

- 2006/42/EC - Machinery Directive
- 2006/95/EC - Low Voltage Directive
- 2004/108/EC - EMC Directive

**And that the standards referenced below have been applied:**

- Safety: EN 60745-1:2009 - Hand-held Motor-operated Electric Tools - Safety - Part 1: General Requirements
- EMC Emissions: EN 61000-6-4:2007 – Generic Industrial Emissions  
EN 55011:2006 – Conducted Emissions  
EN 61000-3-2:2006 – Harmonic Current Emissions  
EN 61000-3-3:1995+A1:2001+A2:2005 – Voltage Fluctuations and Flicker  
EN 50366:2003+A1:2006 - Electromagnetic Fields
- EMC Immunity: EN 61000-6-2:2005 - Generic Industrial Immunity  
EN 61000-4-2:1995+A1:1999+A2:2001 - ESD  
EN 61000-4-3:2006 – Radiated RF  
EN 61000-4-4:2004 – EFT / Burst  
EN 61000-4-5:2005 - Surge  
EN 61000-4-6:2007 – Conducted RF  
EN 61000-4-8:1993+A1:2001 – Magnetic Fields  
EN 61000-4-11:2004 – Voltage Dips / Interruptions

2011/65/EC RoHS (recast)

**Year of CE marking:** 2010

The authorized representative located within the community maintains a copy of the technical documentation required by the directives: Panduit Europe LTD, West World, West Gate, London W5 IXP. Phone: +44 (0) 20 8601 7219, FAX: +44 (0) 20 8601 7220, E-mail: [CS-emea@panduit.com](mailto:CS-emea@panduit.com).



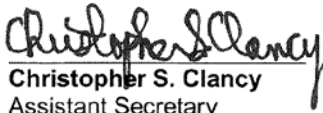



I hereby declare that the product named above meets the essential requirements of, is in conformity with, and the CE mark has been applied according to, the relevant EC directives listed above using the relevant sections of the EC standards and other normative documents listed above.



**Christopher S. Clancy**  
Assistant Secretary  
Panduit Corp

**Date:** December 13, 2012  
**Place:** Tinley Park, Illinois, USA

**TABLE OF CONTENTS**

<b>TABLE OF CONTENTS.....</b>	<b>1</b>	<b>7: OPERATION .....</b>	<b>17</b>
<b>1: INTRODUCTION.....</b>	<b>1</b>	7A: START UP CHECKLIST .....	17
<b>2: SYSTEM SPECIFICATIONS.....</b>	<b>1</b>	7B: CABLE TIE INSTALLATION .....	17
2A: PAT2S / PAT3S TOOL.....	1	7C: CABLE TIE INSTALLATION TECHNIQUES.....	18
2B: PDS / PD3S DISPENSER.....	2	7D: TIP COLLECTOR .....	18
2C: PDSF FRAME .....	2	 7E: CABLE TIE TENSION.....	19
2D: PD3SF FRAME (SEE DOCUMENT NO. PA26268A01).....	2	7F: ERROR MESSAGES .....	19
2E: PHS2 / PHS3 FEEDER HOSES .....	2	7G: FUNCTIONAL MESSAGES.....	25
2F: ADDITIONAL COMPONENTS.....	3	7H: STATUS MESSAGES .....	26
PL283N1 FILTER/REGULATOR .....	3	<b>8: MAINTENANCE .....</b>	<b>27</b>
PDH10-37 AIR SUPPLY HOSE .....	3	8A: DAILY PREVENTIVE MAINTENANCE.....	27
<b>3: GENERAL POWER TOOL SAFETY WARNINGS .....</b>	<b>3</b>	8B: EXTENDED MAINTENANCE.....	27
 3A: WORK AREA SAFETY .....	4	8C: CLEANING THE TOOL SENSOR LENS.....	28
 3B: ELECTRICAL SAFETY PRACTICES .....	4	8D: CLEANING THE EXIT SENSOR LENS .....	28
 3C: OPERATIONAL SAFETY PRACTICES .....	5	<b>9: MAINTENANCE LOG.....</b>	<b>29</b>
 3D: PERSONAL SAFETY .....	6	<b>10: TROUBLESHOOTING .....</b>	<b>30</b>
 3E: POWER TOOL USE AND CARE .....	6	10A: ERROR MESSAGES TROUBLESHOOTING CHECKLIST .....	30
 3F: SERVICE .....	7	10B: FUNCTIONAL MESSAGE TROUBLESHOOTING .....	32
<b>4: EMISSIONS FOR CLASS A .....</b>	<b>7</b>	10C: CABLE TIE INSTALLATION TROUBLESHOOTING ...	32
USA FCC EMISSIONS FOR CLASS A.....	7	<b>11: "QUICK REFERENCE" MENUS .....</b>	<b>33</b>
CANADIAN EMISSIONS FOR CLASS A.....	7	11A: OPERATOR MENUS .....	33
EUROPEAN EMISSIONS WARNING FOR CLASS A.....	7	11B: SETUP MENUS .....	33
<b>5: TECHNICAL SPECIFICATIONS.....</b>	<b>8</b>	11C: CABLE TIE CONDITION FACTORS .....	35
5A: AIR SUPPLY .....	8		
5B: ELECTRICAL SPECIFICATIONS .....	8		
5C: NOISE EMISSION: .....	9		
5D: VIBRATION: .....	9		
<b>6: INSTALLATION.....</b>	<b>10</b>		
6A: PDS DISPENSER & PDSF FRAME MOUNTING .....	10		
6B: PD3S DISPENSER & PD3SF FRAME MOUNTING.....	11		
6C: SYSTEM CONNECTION .....	12		
6D: INSTALLATION CHECKLIST .....	12		
6E: PDS / PD3S LOADING PROCEDURE .....	12		
6F: PDS / PD3S RELOADING PROCEDURE .....	13		
6G: SYSTEM SETUP AND MENUS.....	13		

## 1: INTRODUCTION

The PAT2S/PAT3S System consists of the PAT2S/PAT3S Cable Tie Installation Tool, PDS/PD3S Dispenser, PDSF Frame/PD3SF Frame, and PHS Hose Assembly. These four units are used together to perform high volume automatic cable tie installation around bundle diameters up to 1.94" (49mm) – PAT2S; and 2.75" (70 mm) – PAT3S. The PLT2S-VMR (PAT2S) or PLT3S-VMR (PAT3S) Cable Ties used in this system provide a high loop tensile strength of 50 pounds (222 Newtons), minimum.



*In the interest of higher quality and value, Panduit is constantly improving and updating our products. Consequently, pictures herein may vary from the actual product.*

## 2: SYSTEM SPECIFICATIONS

THE FOUR MAJOR COMPONENTS OF THE SYSTEM INCLUDE . . .

### 2A: PAT2S / PAT3S TOOL

The PAT2S/PAT3S Cable Tie Installation Tool is pneumatically and electrically powered, and electronically controlled by the PDS/PD3S Dispenser. Designed for easy operation: hand held, lightweight, right or left hand use. The tool jaws are normally open for easy positioning around wire harnesses and the jaws are closed by pulling up on the trigger before application of the cable tie. After the cable tie has been applied, the jaws are re-opened upon release of the trigger for positioning of the tool at the next cable tie location. The PAT2S/PAT3S Tool can be mounted to the PATSBM Bench Mount to perform hands-free, foot pedal actuation of the PAT2S/PAT3S System.

Tool Type	Pan-Ty Cable Ties	Cable Tie Size	Max. Bundle Dia.	Reel Quantity
PAT2S	PLT2S-VMR*	.190" (4.8 mm) wide x 8.1" (206 mm) long	1.94" (49 mm)	2500 Cable Ties
PAT3S	PLT3S-VMR*	.190" (4.8 mm) wide x 11.3" (287 mm) long	2.75" (70 mm)	2500 Cable Ties

	*Available in multiple materials.
	<p><b>LENGTH:</b> 12.8" (325 mm)</p> <p><b>WIDTH:</b> 1.9" (47 mm)</p> <p><b>HEIGHT:</b> 13.5" (343 mm)</p> <p><b>WEIGHT:</b> 3.5 lbs. (1,6 kg)</p> <p><b>HANDLE SIZE:</b> 1.67" (42,4 mm) thick x 1.23" (31,2 mm) wide</p> <p><b>JAW ENVELOPE:</b> 2" (50,8 mm) x 3" (76,2 mm) oval</p> <p><b>JAW WIDTH (PAT2S):</b> 0.33" (8,4 mm) thick</p> <p><b>JAW WIDTH (PAT3S):</b> 0.33" (8,4 mm) thick</p> <p><b>TRIGGER FORCE:</b> 2.0 lbs. (0,91 kg)</p> <p><b>TRIGGER STROKE:</b> 0.80" (20,3 mm)</p>

## 2B: PDS / PD3S DISPENSER

The PDS/PD3S Dispenser is responsible for controlling the PAT2S/PAT3S Tool operation. The dispenser has an electronic display that indicates the proper operation and functions of the system. The display provides a step-by-step menu for feature selections and helps to identify errors to reduce downtime. The display also functions in conjunction with the audible alarm, providing the operator with the specific status of certain malfunctions, such as: Dispenser jam, Tie in hose, Tie in tool, etc. Each message is explained in the Error Messages, Functional Messages, or Functional Troubleshooting Checklist sections. The dispenser includes a resettable counter that can record tie counts for production runs and maintenance intervals. A collection bin is also included to collect the carrier strip (remaining scrap as the cable ties are detached from the continuous strand) from one complete reel of cable ties.

### PDS Dispenser alone:

<b>WIDTH:</b>	16.5" (419 mm)
<b>DEPTH:</b>	18.5" (470 mm)
<b>HEIGHT:</b>	8.0" (204 mm)
<b>WEIGHT:</b>	46.5 lbs. (21,1 kg)

### PD3S Dispenser alone:

<b>WIDTH:</b>	20.6" (525 mm)
<b>DEPTH:</b>	18.6" (471 mm)
<b>HEIGHT:</b>	8.0" (204 mm)
<b>WEIGHT:</b>	49.5 lb (22.3 kg)

## 2C: PDSF FRAME

The PDSF Frame supports the PDS Dispenser above the cable tie reel as the cable ties are unreeled and loaded into the dispenser. The frame can be used as a free-standing unit, or it can be mounted permanently to a bench or a cart.

### Frame alone:

<b>LENGTH:</b>	24.0" (610 mm)
<b>WIDTH:</b>	17.0" (432 mm)
<b>HEIGHT:</b>	12.0" (305 mm)
<b>WEIGHT:</b>	11.6 lbs. (5,3 kg)

### Overall System (Dispenser, Frame and Reel):

<b>LENGTH:</b>	27.5" (699 mm)
<b>WIDTH:</b>	19.0" (483 mm)
<b>HEIGHT:</b>	19.0" (483 mm)
<b>WEIGHT:</b>	64.2 lbs. (29,2 kg)

## 2D: PD3SF FRAME (see Document No. PA26268A01)

## 2E: PHS2 / PHS3 FEEDER HOSES

The PHS Feeder Hose connects the PAT2S/PAT3S Tool to the PDS/PD3S Dispenser with quick connect couplings on both hose ends. The ends are interchangeable, allowing either end to be connected to the tool or dispenser. The feeder hose allows a single cable tie to be blown from the dispenser through the hose to the tool, each cycle.

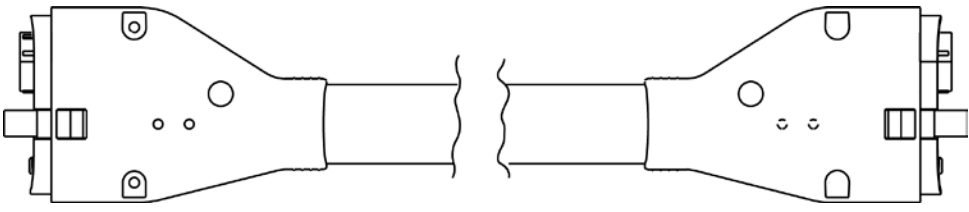

PHS HOSE	LENGTH	WIDTH	HEIGHT	WEIGHT
PHS2	2 m (6.6 ft)	1.3" (34 mm)	2.6" (67 mm)	1.5 lbs. (0,68 kg)
PHS3	3 m (9.8 ft)			2.2 lbs. (1,00 kg)

## 2F: ADDITIONAL COMPONENTS

### PL283N1 Filter/Regulator



A filter/regulator with a 40 micron maximum element rating must be used to supply the PDS/PD3S Dispenser with clean air and to ensure proper air pressure regulation. The PL283N1 Filter/Regulator meets the requirements of the PDS/PD3S Dispenser, and it is recommended for best results. The PL283N1 includes a 1/4" male quick connect plug and provides 16 cfm at 85 PSIG (7,5 L/sec. at 5,8 bar).

### PDH10-37 Air Supply Hose

The Panduit PDH10-37 Air Supply hose is approximately 10 ft. (3 m) long. The hose includes a 3/8 NPT male pipe thread fitting for attaching the hose to the PL283N1 Filter/Regulator. A 1/4" female quick disconnect fitting is included on the opposite end of the hose for connection to the dispenser.



## 3: GENERAL POWER TOOL SAFETY WARNINGS

The PAT2S/PAT3S System is pneumatically and electrically operated and electronically controlled. Therefore, certain safety practices must be followed.

	 <b>WARNING</b>
	<ul style="list-style-type: none"> <li>• <b>Read all safety warning and all instructions. Failure to follow the warnings and instructions may result in electric shock, fire and/or serious injury.</b></li> <li>• <b>Save all warnings and instructions for future reference.</b></li> <li>• The term “power tool” in the warnings refers to your main-operated (corded) power tool or battery-operated (cordless) power tool.</li> </ul>



	<p><b>Panduit Corp. recommends the tool be used with all installed safety features. Customer assumes all liability for injury that could result from improper use of this tool and responsibility for all necessary training to ensure safe operation of this tool.</b></p>
	<ul style="list-style-type: none"> <li>• <b><i>FOR INSTALLATION AND USE BY TRAINED PERSONNEL ONLY.</i></b></li> </ul>
	<ul style="list-style-type: none"> <li>• <b><i>IF ANY DAMAGE TO THE PRODUCT IS APPARENT OR SUSPECTED, DO NOT USE THE PRODUCT. REFER PRODUCT TO QUALIFIED SERVICE PERSONNEL.</i></b></li> </ul>
	<ul style="list-style-type: none"> <li>• <b><i>FCC WARNING: CHANGES OR MODIFICATIONS TO THE PRODUCT COULD VOID THE USER’S AUTHORITY TO OPERATE THE PRODUCT.</i></b></li> </ul>

 **3A: WORK AREA SAFETY**





	<p> <b>WARNING</b></p> <p><b>DO NOT OPERATE POWER TOOLS IN EXPLOSIVE ATMOSPHERES, SUCH AS IN THE PRESENCE OF FLAMMABLE LIQUIDS, GASES OR DUST.</b></p> <p><i>Power tools create sparks which may ignite the dust or fumes.</i></p> <p><i>Provide adequate ventilation around the product.</i></p>	
		<p> <b>WARNING</b></p> <p><b>KEEP WORK AREA CLEAN AND WELL LIT.</b> <i>Cluttered or dark areas invite accidents.</i></p> <p><b>KEEP CHILDREN AND BYSTANDERS AWAY WHILE OPERATING A POWER TOOL.</b> <i>Distractions can cause you to lose control.</i></p>

 **3B: ELECTRICAL SAFETY PRACTICES**

	<p><b><u>GROUNDING:</u></b> In the event of a malfunction or breakdown, grounding provides a path of least resistance for electric current which reduces the risk of electrical shock. This tool is equipped with an electric cord that includes an equipment-grounding conductor and a grounding plug. The plug must be inserted into a matching outlet that is properly installed and grounded in accordance with all local codes and ordinances.</p> <p><b>DO NOT modify the plug provided. If it will not fit the outlet, have the proper outlet installed by a qualified electrician.</b></p> <p><b>Use only 3-wire extension cords that have 3-prong grounding plugs and 3-pole receptacles that accept the tool's plug. Replace a damaged or worn cord immediately.</b></p> <p><b>Avoid body contact with earthed or grounded surfaces, such as pipes, radiators, ranges and refrigerators.</b> <i>There is an increased risk of electric shock if your body is earthed or grounded.</i></p> <p><b>DO NOT abuse the cord. Never use the cord for carrying, pulling or unplugging the power tool. Keep cord away from heat, oil, sharp edges or moving parts.</b> <i>Damaged or entangled cords increase the risk of electric shock.</i></p>
---	--

	<p> <b>WARNING</b></p> <p><b>Power tool plugs must match the outlet. Never modify the plug in any way. Do not use any adapter plugs with earthed (grounded) power tools.</b> <i>Unmodified plugs and matching outlets will reduce risk of electric shock.</i></p>
---	--





	 <b>WARNING</b>
	<p><b>ONLY OPERATE THE PAT2S/PAT3S SYSTEM IN A CLEAN, DRY, INDOOR ENVIRONMENT.</b></p> <p><b>DO NOT EXPOSE POWER TOOLS TO RAIN OR WET CONDITIONS.</b> <i>Water entering a power tool will increase the risk of electric shock.</i></p> <p><b>If operating a power tool outdoors, use an extension cord suitable for outdoor use.</b> <i>Use of a cord suitable for outdoor use reduces the risk of electric shock.</i></p> <p><b>If operating a power tool in a damp location is unavoidable, use a residual current device (RCD) protected supply.</b> <i>Use of an RCD reduces the risk of electric shock.</i></p> <p>NOTE: The term “residual current device (RCD)” may be replaced by the term “ground fault circuit interrupter (GFCI)” or “earth leakage circuit breaker (ELCB)”.</p>
	 <b>KEEP AWAY FROM LIVE CIRCUITS:</b>
	<ul style="list-style-type: none"> <li>• Operating personnel must not remove covers.</li> <li>• Replacement of components and internal adjustments must be made by qualified maintenance personnel.</li> <li>• Disconnect power cable when replacing components.</li> <li>• Dangerous voltages may exist even with the power cable removed.</li> <li>• To avoid injuries, always disconnect power and discharge circuits by grounding before touching circuitry.</li> <li>• Input connection to the product must remain accessible as a disconnect device.</li> <li>• DO NOT work on the product; connect or disconnect cables during periods of lightning.</li> <li>• Provide wiring per national and local electrical codes.</li> </ul>

### 3C: OPERATIONAL SAFETY PRACTICES

1. DO NOT insert fingers in between the jaws of the tool or the rotary receiver area of the dispenser.
2. DO NOT attempt to operate the tool with cover open and the safety mechanism disabled.
3. DO NOT attempt to operate the tool with the cover open; the system will not cycle.
4. DO NOT operate the tool with the rear jaw held open. Cable ties may be ejected from the tool at high velocities.
5. DO NOT operate the tool near anyone's face.
6. DO NOT operate the tool without a wire bundle in the jaws.
7. DO NOT operate the tool with any object blocking the path of the cable tie around the jaws.

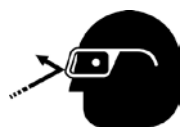
**3D: PERSONAL SAFETY**

	<p><b>WARNING</b></p> <p>Use personal protective equipment. Safety glasses must be worn at all times by all persons within ten (10) feet of any part of the system. Protective equipment such as dust mask, non-skid safety shoes, hard hat, or hearing protection used for appropriate conditions will reduce personal injuries.</p>
	<p><b>WARNING</b></p> <p>Hearing protection is recommended to be worn during operation of tool.</p>

1. **STAY ALERT, watch what you are doing and use common sense when operating a power tool. Do not use a power tool while you are tired or under the influence of drugs, alcohol or medication.**  
*A moment of inattention while operating power tools may result in serious personal injury.*
2. **Prevent unintentional starting. Ensure the switch is in the off-position before connecting to power source and/or battery pack, picking up or carrying the tool.**  
*Carrying power tools with your finger on the switch or energizing power tools that have the switch on invites accidents.*
3. **Remove any adjusting key or wrench before turning the power tool on.**  
*A wrench or a key left attached to a rotating part of the power tool may result in personal injury.*
4. **Do not overreach. Keep proper footing and balance at all times.**  
*This enables better control of the power tool in unexpected situations.*
5. **Dress properly..Do not wear loose clothing or jewelry. Keep your hair, clothing and gloves away from moving parts.**  
*Loose clothes, jewelry or long hair can be caught in moving parts.*
6. **If devices are provided for the connection of dust extraction and collection facilities, ensure these are connected and properly used.**  
*Use of dust collection can reduce dust-related hazards.*

**3E: POWER TOOL USE AND CARE**

1. **Do not force the power tool. Use the correct power tool for your application.**  
*The correct power tool will do the job better and safer at the rate for which it was designed.*
2. **Do not use the power tool if the switch does not turn it on and off.**  
*Any power tool that cannot be controlled with the switch is dangerous and must be repaired.*
3. **Disconnect the plug from the power source and/or the battery pack from the power tool before making any adjustments, changing accessories, or storing power tools.**  
*Such preventive safety measures reduce the risk of starting the power tool accidentally.*
4. **Store idle power tools out of the reach of children and do not allow persons unfamiliar with the power tool or these instructions to operate the power tool.**  
*Power tools are dangerous in the hands of untrained users.*

5. **Maintain power tools. Check for misalignment or binding of moving parts, breakage of parts and any other condition that may affect the power tool's operation. If damaged, have the power tool repaired before use.**  
*Many accidents are caused by poorly maintained power tools.*
6. **Keep cutting tools sharp and clean.**  
*Properly maintained cutting tools with sharp cutting edges are less likely to bind and are easier to control.*
7. **Use the power tool, accessories and tool bits, etc. in accordance with these instructions, taking into account the working conditions and the work to be performed.**  
*Use of the power tool for operations different from those intended could result in a hazardous situation.*



### 3F: SERVICE

- Have your power tool serviced by a qualified repair person using only identical replacement parts.

Contact Panduit Tool Service at the following locations:

<p><b>Panduit Tool Solutions Division (USA)</b> 16530 163<sup>rd</sup> Street Lockport, IL 60441</p> <p><b>Tel 888-506-5400, ext. 83255</b></p>	<p><b>Panduit EMEA Service Center (EUR)</b> EMEA Tool Service Center Bedrijvenpark Twente 360 7602 KL Almelo <b>tel + 31 546 580 451</b></p>
---	--

*This will ensure that the safety of the power tool is maintained.*

## **4: Emissions for Class A**

### **USA FCC Emissions for Class A**

This device complies with part 15 of the FCC Rules.

Operation is subject to the following two conditions: (1) this device may not cause harmful interference, and (2) this device must accept any interference received, including interference that may cause undesirable operation.

### **Canadian Emissions for Class A**

This Class "A" digital apparatus meets all requirements of the Canadian Interference Causing Equipment Regulations.

Cet appareil numérique de la classe "A" respecte toutes les exigences du Règlement sur le matériel brouilleur du Canada.

### **European Emissions Warning for Class A**

Product is not intended for use in a residential environment. Use of this product in residential areas may cause electromagnetic interference.

The information contained in this manual is based on our experience to date and is believed to be reliable. It is intended as a guide for use by persons having technical skill at their own discretion and risk. We do not guarantee favorable results or assume any liability in connection with its use. Dimensions contained herein are for reference purposes only. For specific dimensional requirements consult the factory. This publication is not to be taken as a license to operate under, or a recommendation to infringe any existing patents.

**5: TECHNICAL SPECIFICATIONS****5A: AIR SUPPLY**

ITEM	DESCRIPTION
Recommended regulated air pressure <u>to dispenser</u> (pressures other than recommended may result in unsatisfactory operation):	Regulator settings: 65 PSIG (4,5 bar) with a max. 10 PSI (0,7 bar) drop. DO NOT EXCEED 85 PSIG (5,8 bar).
Air consumption at 25 cycles per minute:	7 cfm @ 65 PSIG (3,3 L/sec @ 4,5 bar)
Line pressure <u>to regulator</u> :	Minimum 70 PSIG (4,8 bar), Maximum 125 PSIG (8,5 bar)
Filter/regulator requirements:	40 micron maximum element rating, 5 PSI (0,3 bar) maximum pressure drop @ 70 PSIG (4,8 bar) inlet pressure and 12 cfm (5,7 L/sec) flow minimum.
Lubrication for air supply:	Airline lubricators are NOT to be used.
Recommended filter/regulator unit (supplied by user) 3/8" NPT ports:	Recommended source: Panduit Part Number: PL283N1 (See Page 3). <i>Panduit EU Part Number: HS3X</i>
Recommended main air supply hose from filter/regulator to dispenser (supplied by user):	Recommended source: Panduit Part Number: PDH10-37 (See Page 3).

**5B: ELECTRICAL SPECIFICATIONS**

ITEM	DESCRIPTION
Recommended Voltage (PDS/PD3S Dispenser)	115 / 230 VAC (50/60 Hz)
Power	300 W
Phase	Single Phase
Dispenser Protection	2 - Fuses (included) - 4A x 250 V (CA21138A01) Short circuit interrupting capacity - 100A
Power to Tool	Logic -- 5 V , 500 mA Motor -- 24 V , 1A (mean)
Cord set supplied with PDS/PD3S Dispenser	115 V ~ cord set supplied with 3-prong male (NEMA 5.15) to user supply (For 115 V ~ operations only).
	<i>(For 230 V ~ operations only). Not all versions.</i> 230 V ~ cord set supplied with 2-prong male (CEE 7/7 & CEE 7/4) to user supply

This unit includes EMI/RFI filters, however it is possible that infrequent electrical phenomena may cause tool function to be temporarily interrupted. This interruption can be corrected by turning the tool "off" (removing the cable tie if necessary), and then back "on" again.

**5C: NOISE EMISSION:**

The noise emission, measured in accordance with EN620745-1: 2009	
Surface sound pressure level [dB(A) re. 20 $\mu$ Pa]	79.3
K1 (correction for background noise)	0
K2 (correction for test environment)	0
10 log S / So (r=1m)	11
Measured sound power level LwA [db(A) re 1pW]	90.3

**5D: VIBRATION:**

The vibration total value and its uncertainty measured in accordance with EN60745: 2009	
Vibration Peak Value Avg. ahv:	0.538 m/s <sup>2</sup>
<p>The following information:</p> <ul style="list-style-type: none"> <li>• That the declared vibration total value has been measured in accordance with a standard test method and may be used for comparing one tool with another;</li> <li>• That the declared vibration total value may also be used in a preliminary assessment of exposure.</li> </ul>	
<p>A warning:</p> <ul style="list-style-type: none"> <li>• That the vibration emission during actual use of the power tool can differ from the declared total value depending on the ways in which the tool is used; and</li> <li>• Of the need to identify safety measures to protect the operator that are based on an estimation of exposure in the actual conditions of use (taking account of all parts of the operating cycle such as the times when the tool is switched off and when it is running idle in addition to the trigger time).</li> </ul>	

## 6: INSTALLATION

### 6A: PDS DISPENSER & PDSF FRAME MOUNTING

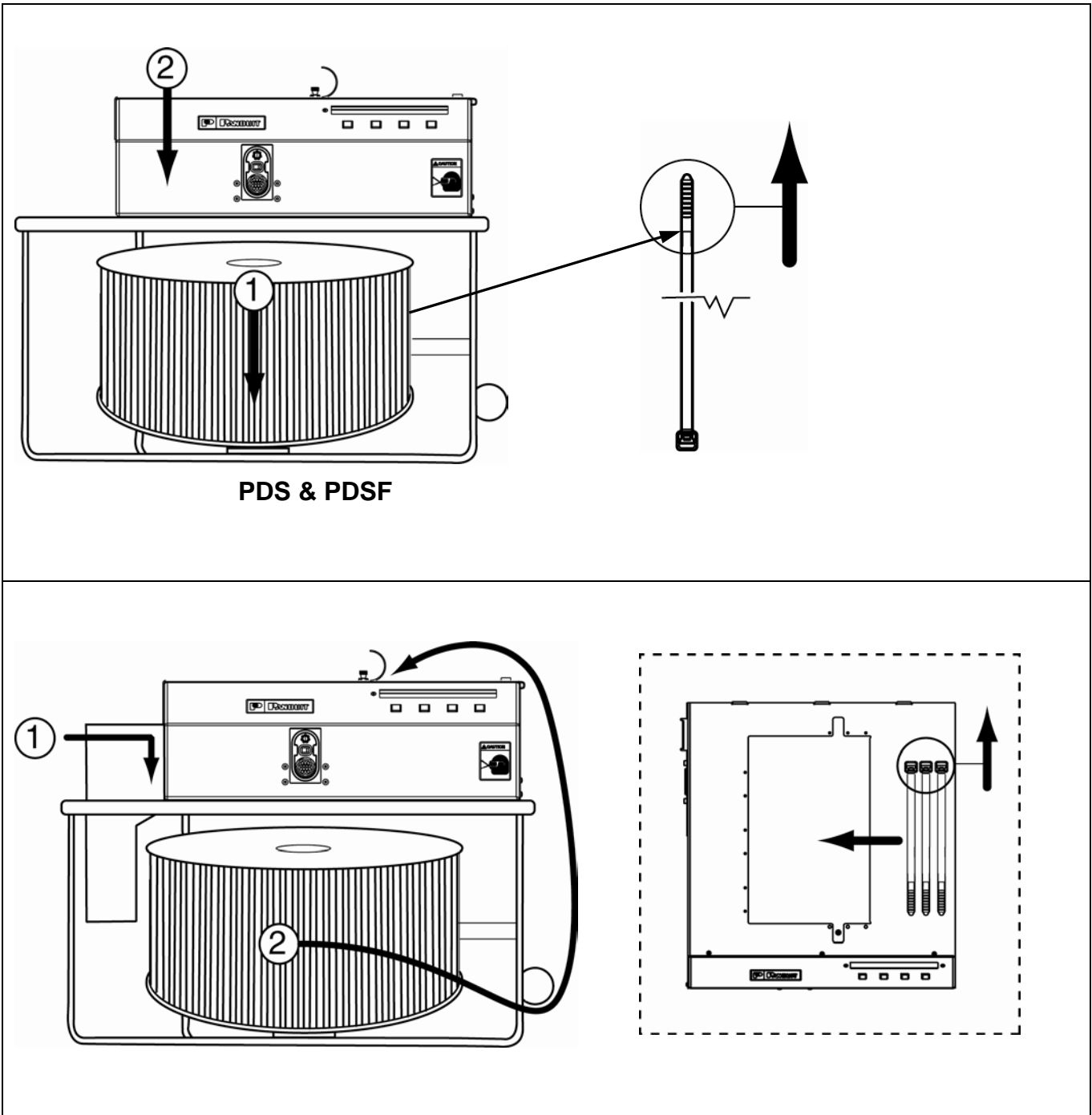

Always position the dispenser and frame in the work area so there are no severe bends or twists in the PHS Feeder Hose.

6B: PD3S DISPENSER & PD3SF FRAME MOUNTING

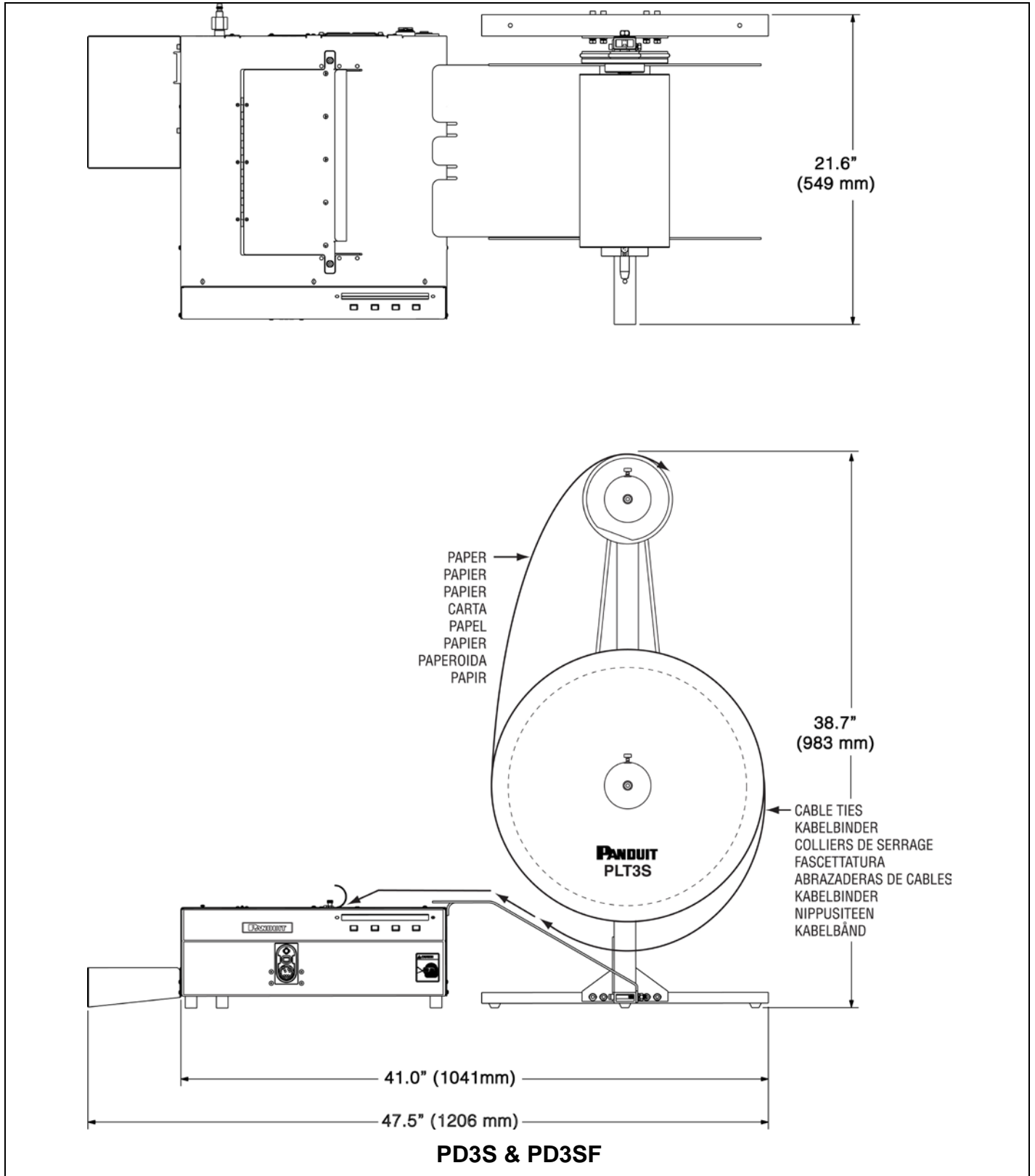

## 6C: SYSTEM CONNECTION

1. Connect the female quick disconnect end of the air hose and filter/regulator assembly to the male air inlet on the back of the dispenser.  
**DO NOT CONNECT THE FILTER/REGULATOR TO THE MAIN AIR SUPPLY AT THIS TIME.**
2. Connect the filter/regulator to the main (NON-LUBRICATED) air supply and set the filter/regulator at 65 PSIG for optimum performance (See Air Supply on Page 8).
3. Verify installation by reviewing the Installation Checklist (See below).
4. Connect PDS/PD3S power cord to an 115VAC; or 230VAC socket outlet, with a minimum 10 Amp capacity.

## 6D: INSTALLATION CHECKLIST

1. Have you made sure that the air supply is NON-LUBRICATED (from any source)?
2. Is the main air supply hose to the dispenser clean and sized properly? (3/8" inside diameter minimum, 10'-0" (3 m) length maximum from filter/regulator to dispenser)
3. Is the filter element rating correct? (40 micron maximum)
4. Is the filter/regulator equivalent to recommended? (See Page 8.)
5. Are the quick-connect fittings equivalent to recommended? (See Page 8.)
6. Is the filter/regulator located as close to the dispenser as possible? (10' - 0" (3 m) maximum)
7. Is the dispenser placed or mounted in a convenient location? (See Dispenser Mounting above.)
8. Is the regulated airline pressure to dispenser sufficient? (See Air Supply on Page 8.)
9. Is the socket outlet rated 115VAC; or 230VAC, with a 10 Amp minimum capacity?

## 6E: PDS / PD3S LOADING PROCEDURE

1. Plug the supplied electric cord into the receptacle on the back of the dispenser. Plug the other end into a grounded electrical outlet that matches the dispenser power requirements (See Electrical Specifications on Page 8). Set the power switch on the back of the dispenser to the "on" position. The dispenser rotary receiver will rotate slightly to align itself and the message "Panduit -- Tool is ready" will appear on the electronic display for two seconds. The dispenser is now ready for loading.
2. Remove the cable tie reel from the protective plastic bag. Remove the corrugated cardboard wrap from around the cable ties. Remove the cellophane tape from the end of the cable tie strip and discard.
3. Pull the end of the cable tie strip under the roller guide on the frame so that the cable tie tips point toward you. Continue pulling the strip upward around the roller guide and around the top edge of the dispenser (PDS). Lay the cable tie carrier strip in the slot of the corner guide on the top right edge of the dispenser. Verify that the cable tie tips are toward you and that the cable tie heads are toward the back of the dispenser as the cable tie strip moves closer to the dispenser cover opening.
4. Guide the cable tie carrier strip against the back edge of the ramp as the cable ties enter the cover opening. Slide the carrier strip into the opening until it stops. At this point, the first cable tie is located in the rotary receiver slot. While maintaining a slight inward pressure on the cable ties, press the "Load" button once, to feed the first cable tie. If the carrier strip and cable tie are fed correctly, press and HOLD the "Load" button until eight more cable ties are fed. As each cable tie is loaded, the number next to "Load" will decrease for each cable tie loaded. The dispenser cover must be closed and latched to load or cycle the system. The rotary receiver will not advance if the cover is open

**NOTE:** If the cable ties are not feeding correctly, release the "Load" button immediately. Next, press the "Unload" button to reverse the rotary receiver's rotation and back the cable ties out of the dispenser. Hold the "Unload" button down until all of the cable ties have exited. NEVER pry the rotary receiver, or turn it, or touch it with your hand. Only use the "Load" or "Unload" buttons to rotate the rotary receiver. Press the "Menu" button to advance to the "Reset" display. Now, press the "Reset Load" button to reset the "Load" counter to "nine" cable ties. Cut the excess carrier strip and any distorted or damaged cable ties from the cable tie strip. Slide the carrier strip into the



cover opening until it stops. Press and HOLD the "Load" button until nine cable ties have loaded. Any extra cable ties loaded will drop out of the dispenser onto the top of the cable tie reel.

5. Connect either end of the PHS Feeder Hose to the PDS/PD3S Dispenser connection block. Align the connectors and, while pressing the disconnect tabs, push the hose end onto the dispenser connection block until the latches engage. Connect the other end of the feeder hose to the PAT2S/PAT3S Tool in the same manner. The system is now ready for operation.
6. Place the tool jaws around a bundle and cycle the PAT2S/PAT3S Tool by lifting up on the trigger. Advance to the Cable Tie Installation section on Page 17 after fine tuning the air pressure setting (at the filter/regulator) according to the following:
7. If the cable tie will not loop around the jaws of the tool, increase the line pressure by 5 PSIG.
8. If the cable tie releases after being tensioned, decrease the line pressure by 5 PSIG.

NOTE: Fine tune air pressure within recommended regulated air pressure (Refer to Air Supply on Page 8).

## 6F: PDS / PD3S RELOADING PROCEDURE

1. The carrier strip scrap bin will hold one reel of scrap (one reel = full collection bin). To maintain an exit for carrier strip scrap, the scrap bin should be emptied whenever a full reel of cable ties is loaded. The carrier strip scrap bin should be lifted off the dispenser, emptied and replaced.
2. Before loading a full reel, press the "Unload" button to verify that any remaining ties on the carrier strip are pulled out of the dispenser. Continue to press the "Unload" button until all of the remaining cable ties have dropped out of the rotary receiver.
3. Disconnect the PHS Feeder Hose from the dispenser by pressing the disconnect tabs on the hose coupling and pulling the hose away from the dispenser. This will ease removal of the empty cable tie reel and replacement with a full one. Once the full cable tie reel is positioned correctly, and the carrier strip is loaded into the dispenser, press the "Menu" button to bring up the "Reset" display. Then, press the "Reset load" button to reset the "Load" counter to nine and continue with the standard loading procedure. To reload, follow the Loading Procedure on Page 12, beginning with Step 2.

## 6G: SYSTEM SETUP AND MENUS

The PDS/PD3S Dispenser is menu driven from the LCD display. The menu has six (6) different levels that can be advanced or exited, by pressing the designated buttons. The instructions below are for the lead person or setup person only. For quick startup instructions and to begin cable tie installation, refer to the *Operation* section on Page 17.

1. Plug the supplied electric cord into the receptacle on the back of the dispenser. Plug the other end into a grounded electrical outlet that matches the dispenser power requirements (Refer to the *Electrical Specifications* section on Page 8). Set the power switch on the back of the dispenser to the "on" position. The dispenser rotary receiver will rotate slightly to align itself, and

The following display will appear for 5 seconds:

Panduit	rX.X
Tool is ready	

followed by:

**LEVEL 1 - Operator Menu ("Load, Unload, Menu" Display)**

Loads : XX	XXXXXXXX
Load	Unload MENU

This is the Level 1 menu ("Load, Unload, MENU" Display). The "XX" represents the number of ties needed to be advanced into the rotary receiver, before the dispenser can be cycled.

When the "**Load**" button is pressed, the number will decrease as the rotary receiver advances each tie. Once the 9 ties are advanced, the number and "Load" function disappears. (To load the dispenser, refer to the *Loading Procedure* section on Page 12.) The number (XXXXXXXX) on the right side of the display is the user resettable counter (See Level 3) that keeps track of the number of cable ties successfully applied.

The "**Unload**" button reverses the rotary receiver in order to unload or clear jams. The gearing of the dispenser will not allow turning the rotary receiver by hand. Only use the "Load" and "Unload" functions to rotate the rotary receiver. The rotary receiver will not move if pried.

The "**MENU**" button will advance to the next menu level to activate the other dispenser functions. The functions are in a preset order similar to a staircase. To reach a desired level, you must walk through each stairway before that level. Press the "Menu" button to go up (forward) one level, or press the "Exit" button to go down (back) one level. The "Escape" button can be pressed to go directly to Level 1 or 1B Operator Menus (Refer to the *Cable Tie Installation* section on Page 17). It is important to note that the tool will only cycle cable ties when the display is returned to the Level 1 or 1B Operator Menus ("Load, Unload, Menu" Display).

2. Press the "**MENU**" button to bring up the Level 2 menu:

**LEVEL 2 - Load and Counter Reset Menu ("Reset" Display)**

Resets load and/or counter		
Reset Ld	Reset Ct	Exit

The "**Reset Ld**" button will return to the last menu level (Level 1) while also resetting the Load counter back to "9". This allows the unit to be reloaded (To reload the dispenser, follow the Reloading Procedure on Page 13).

Pressing the "**Reset Ct**" button will zero the "resettable counter" on the Level 1 menu.

There is not a "**MENU**" button in this level (Level 2) since it is the last menu level for operator use. The following procedure is for lead person or setup person only.

The "**Exit**" button will return to the last menu level (Level 1). If **ONLY** the "Exit" button is pressed, the load counter and or the "resettable counter" will remain unchanged. See Step 1.

3. The display at Level 2 does not show a "Menu" selection at the third button. The Setup menu levels (Level 3 thru Level 6) are not required except to set, or to adjust the unit, and are reached by the following sequence:
  - a. Verify that the Level 2 menu is on the display.
  - b. Press the second button from the right, two times, followed by pressing the button on the far left, one (1) time.

**LEVEL 3 - Total Counts Menu (Dispenser and Tool)**

Shows total counts			
Counters	Escape	Menu	Exit

**IMPORTANT!!** Please note that once you press the "Escape" or "Exit" button to return to menu Level 1, 1B, or 2, you must repeat the sequence (Steps 3.a. and 3.b.) to re-enter the higher menu levels (Level 3 thru Level 6).

Press the "**Counters**" button to view the total count to date for the PDS/PD3S Dispenser and the PAT2S/PAT3S Tool. Pressing this button will bring up the following display:

#### LEVEL 3A

PDS/PD3S	#	XXXXXX	Rev	X.X	Cycles:	XXXXXXX
PAT2S/PAT3S	#	XXXXXX			Cycles:	XXXXXXX

The number (XXXXXX) to the right of each component is the serial number of the particular component. The number (X.X) to the right of "Rev" represents the revision level of the software for the system. The number (XXXXXXX) to the right of "Cycles" represents the number of times the particular component has been cycled. These total counts are not resettable. Press Button 4 to return to the last menu level (Level 3).

Press the "**Escape**" button to return directly to Level 1 or 1B (Operator Menus). See Step 1.

Press the "**MENU**" button to advance to the next menu level (Level 4). See Step 4.

Press the "**Exit**" button to return to the last menu level (Level 2). See Step 2.

**Remember!!** Once you "Escape" out of the Setup menus, you must repeat the sequence (Steps 3.a. and 3.b.) to re-enter the higher menu levels (Level 3 thru Level 6).

#### LEVEL 4 - Chopper Cut Cycle Menu

Turn chopper on/off			
Chopper	Escape	Menu	Exit

4. Press the "**Chopper**" button to view or to change the current status of the chopper ("on" or "off"). Pressing this button will bring up the following display:

#### LEVEL 4A

Chopper is -	On		
On	Off		Exit

The upper statement refers to the current status of the chopper – "Chopper is – on" or "Chopper is – off". When the "Chopper is – on", the chopper will cut the carrier strip every 7 cable ties. When the "Chopper is – off", the chopper will not cut the carrier strip, and one continuous carrier strip will exit the dispenser. Press the "On" button to turn the chopper "on", or press the "off" button to turn the chopper "off". When the desired status is displayed, press the "Exit" button to select that choice and also return to the last menu level (Level 4).

Press the "**Escape**" button to return directly to Level 1 or 1B (Operator Menus). See Step 1.

Press the "**MENU**" button to advance to the next menu level (Level 5). See Step 5.

Press the "**Exit**" button to return to the last menu level (Level 3). See Step 3.

**Remember!!** Once you "Escape" out of the Setup menus, you must repeat the sequence (Steps 3.a. and 3.b.) to re-enter the higher menu levels (Level 3 thru Level 6).

#### LEVEL 5 - Line Pressure Menu

View line pressure			
Pressure	Escape	Menu	Exit

5. Press the **"Pressure"** button to view the current pressure, minimum pressure, and maximum pressure. Pressing this button will bring up the following display:

**LEVEL 5A**

XX PSI	MIN: XX PSI	MAX: XX PSI
BAR/PSI	Clear	Exit

The current line pressure at the dispenser is displayed on the top, far left of the display. The minimum and maximum pressure readings are based on the lowest and highest pressures since the dispenser was turned "on", or since the **"Clear"** button was last pressed. Press the "BAR/PSI" button to select the desired unit for measuring pressure (BAR for Europe or PSI for USA). If the "Clear" button is not pressed after the unit is turned "on", the minimum reading may be 0. The line pressure display is used to verify that the correct supply pressure is being provided. Refer to *Air Supply* section on Page 8 for the recommended operating pressure for optimum performance. Press the "Clear" button to clear the current minimum and maximum readings to verify minimum and maximum readings from that point on.

Press the **"Escape"** button to return directly to Level 1 or 1B (Operator Menus). See Step 1.

Press the **"MENU"** button to advance to the next menu level (Level 6). See Step 6.

Press the **"Exit"** button to return to the last menu level (Level 4). See Step 4.

**Remember!!** Once you "Escape" out of the Setup menus, you must repeat the sequence (Steps 3.a. and 3.b.) to re-enter the higher menu levels (Level 3 thru Level 6).

**LEVEL 6 - Language Menu**

Set language		
Language	Escape	Exit

6. Press the **"Language"** button to select the language at the next menu in which all menus will be displayed. Pressing this button will bring up the following display:

**LEVEL 6A**

English		
↑	↓	Select

**The menu can be displayed in the following languages: English, Deutsch (German), Française (French), Italiana (Italian), Español (Spanish), Czech (Ěeský), Danish (Danske), Swedish (Svenska), and Finish (Suomen).** The current language chosen is shown at the upper left of the display. To select another language, press the "↑" button to scroll "up" thru the language choices, or press the "↓" button to scroll "down" thru the language choices. When the preferred language is displayed at the upper left, press the "Select" button to choose that language, and to return to the last menu level (Level 6). All menus will be displayed in the selected language. If the incorrect language was selected, press the "Language" button to return to Level 8A to select the correct language.

Press the **"Escape"** button to return directly to Level 1 or 1B (Operator Menus). See Step 1.

The **"MENU"** button is unavailable since Level 6 is the last Setup menu.

Press the **"Exit"** button to return to the last menu level (Level 5). See Step 5.

**Remember!!** Once you "Escape" out of the Setup menus, you must repeat the sequence (Steps 3.a. and 3.b.) to re-enter the higher menu levels (Level 3 thru Level 6).

## 7: OPERATION

Follow this operation procedure to correctly apply cable ties. To begin, follow the Start Up Checklist below to assure safety and optimum system operation.

### 7A: START UP CHECKLIST

1. Is the PDS/PD3S Dispenser connected to the air supply? (Refer to the *System Connection* section on Page 12.)
2. Is the air pressure set properly? 65 PSIG with a maximum 10 PSI drop is recommended. (Refer to the *Air Supply* section on Page 8.)
3. Is the PDS/PD3S Dispenser loaded properly? (Refer to the *Loading Procedure* section on Page 12.)
4. Is the PHS Feeder Hose securely connected to the PAT2S/PAT3S and PDS/PD3S Dispenser? (Refer to the *Loading Procedure* section on Page 12.)
5. Is the Level 1 or 1B Operator Menu displayed on the PDS/PD3S Dispenser? The Level 1 or 1B Operator Menu must be displayed on the dispenser for the tool to cycle cable ties. Refer to the *Cable Tie Installation* section (next) for proper menu display.

### 7B: CABLE TIE INSTALLATION

1. Review and follow all of the *Safety Practices* on Page 4, being certain to wear adequate eye protection.
2. Verify that the Level 1 or Level 1B Operator Menu is displayed on the PDS/PD3S Dispenser. The PAT2S/PAT3S Tool can only cycle cable ties if one of the two Operator Menus (below), is displayed.

**The Level 1 Operator Menu looks like this:**

Loads : XX	XXXXXXXX
Load	Unload MENU Exit

**The Level 1B Operator Menu looks like this:**

MENU	XXXXXXXX
------	----------

The Level 1B Operator Menu will only be displayed if the tool was actuated one or more times. Once the tool has been actuated, the loading commands disappear ("Loads: X", "Load", and "Unload").

3. Grasp the tool with either hand, and slip the open jaws around the bundle or item to be cable tied.

**NOTE:** Bundles should be routed at least 3" (76 mm) off the harness board for easy tool jaw access. However, DO NOT allow the wire bundles to be forced into the jaw track. This will hinder the travel of the cable tie around the jaws and could increase the possibility of a misfeed (cable tie tail will be blocked by wire bundle when attempting to feed into cable tie head).

4. When the jaws are positioned at the preferred location for a cable tie, close the rear jaw by lifting the trigger. When the trigger is lifted to the highest point, the tool cycle will start. Hold the trigger momentarily for proper cycling of the tool. The cable tie will be applied, tensioned and cut off.

5. At the completion of the cycle, release the trigger to open the rear jaw. Relocate the tool at the next desired cable tie location and repeat as required.

**NOTE:** If a malfunction occurs, or a cable tie is not applied properly, then a buzzer will sound and an error message will be displayed. Follow the "Help" instructions on display or refer to the *Error Messages* section on Page 19 for more specific instructions.

**HINT:** When applying several cable ties on a long bundle, the tool can be moved along the bundle to each location, and cycled, without opening the jaws. This can be done by slightly relaxing pressure on the tool trigger (but not enough to open the jaws), and then lifting the trigger to the highest point to cycle the tool. With practice, this technique can be accomplished with minimal effort.

## 7C: CABLE TIE INSTALLATION TECHNIQUES

Always use the following cable tie installation techniques to promote continuous trouble-free usage of the PAT2S/PAT3S System. These techniques will prevent incomplete cable tie installations and system interruption.

- Prevent severe bends or twists in the PHS Feeder Hose. This will prevent interference with the cable tie travel to the tool and, in turn, reduce incomplete cycles.
- Dress the wires to result in a compact bundle; 2" (51 mm) in diameter or less for the PAT2S/PAT3S Tool. This will prevent loose cable ties or cable ties that do not stay on the bundle. The maximum bundle diameter is 2" (51mm). Consult factory for minimum bundle diameter applications.
- Hold the tool perpendicular, in both directions, to the bundle or item to be cable tied. Left to right, and top to bottom. This will prevent loose cable ties and cable ties that are not cut off flush to the head.
- Although the tool does not require any specific positioning on the bundle within the jaws, always allow the tool to seek its own position as the cable tie is being tensioned. DO NOT pull on the tool or restrict its movement toward the bundle, or loose cable ties or non-flush cable tie tail cutoffs will result.
- DO NOT place the bundle or item against the back of the jaw area. Misfeeds may result.
- Each harness or item to be cable tied should be supported off the harness board at least 3" (76 mm). Panduit Harness Board Accessories provide the ideal harness height for automatic cable tie application.
- DO NOT install cable ties too close to a previously installed cable tie or a harness support, or any other object on the bundle. Loose cable ties or long cutoffs may result. Always allow enough space between cable ties and other objects, so that the tool can move freely toward the bundle as the cable tie is pulled tight.
- Store the cable ties properly, according to the storage specifications, and use them before the expiration date to prevent dryness and brittleness. Dry or brittle cable ties may break during installation.

## 7D: TIP COLLECTOR

The PAT2S/PAT3S Tool is provided with a tip collector to collect a maximum of 150 cable tie cutoff tips. The tip collector must be emptied before it reaches its capacity.

**NOTE:** Failure to empty the tip collector may cause the tool to malfunction.

To empty the tip collector, push the tip collector forward on the tool and remove. Shake out the cutoff tips. Remount the tip collector on the tool by pushing it on until the latch snaps into place.

## 7E: CABLE TIE TENSION

The tension at which cable ties are installed can be adjusted on the PAT2S/PAT3S Tool. The cable tie tension setting can be viewed thru a window on the top left side of the tool. The right edge of the block (inside the window) indicates the current tension setting. Adjust the tension setting by turning the tension adjustment knob (to the rear of the tension setting window). If cable ties are too loose on the bundle, turn the tension adjustment knob clockwise to increase the tension. If cable ties are too tight on the bundle, turn the tension adjustment knob counterclockwise to decrease the tension. After desired setting is reached, check tension by installing a few cable ties. When the desired tension is achieved, tighten the locking screw to lock the adjustment knob at that setting. The maximum recommended tool tension setting is #6. In very high humidity areas, the maximum tension setting should be reduced.

**NOTE:** DO NOT force the tension adjustment knob with pliers or other tools. Greater or lesser tensions will not result, and tool may be damaged.

## 7F: ERROR MESSAGES

The operator is constantly informed of the PAT2S/PAT3S System's status by the PDS/PD3S Dispenser's electronic display. If the system fails due to operator error or dispenser malfunction, the operator is alerted that an error has occurred by two (2) types of signals: a buzzer signal (audible) and the dispenser display (visual). The buzzer signal volume can be adjusted by turning the faceplate of the buzzer. The buzzer is located on the back of the PDS/PD3S Dispenser next to the power switch.

For each error message that appears, there will be at least three (3) buttons to choose from (on the error message display):

**"Help" button**            Press to receive general instructions to remedy the current problem;

**"Buzzer" button**        Press to turn the buzzer signal "off";

**"Continue" button**        Press to return to the Level 1 or Level 1B Operator Menus so that operation can resume. This button should only be pressed when the problem is understood, and the remedy instructions have been followed. When the operator becomes familiar with the system, he will be able to remedy the problem without advancing to the help displays for instructions.

The following error messages may be displayed at some time during operation of the PAT2S/PAT3S System. By following the instructions on the display, the system will provide "Help" information to remedy the problem so that operation can resume. These messages and instructions will actually teach and assist the operator when a problem occurs. The nature of the problem, solution to the problem, and prevention of the problem are listed to reduce and possibly eliminate the error from occurring again. Specific instructions for the error messages and remedies to the problems are included below.

### ERROR 1 - Out of ties or tie in dispenser

Out of ties or tie in dispenser		
Help	Buzzer	Continue

**POSSIBLE CAUSE:** This usually occurs if the dispenser has run out of cable ties, or if not enough cable ties are loaded into the dispenser, or if a cable tie is prevented from leaving the dispenser.

**CORRECTIVE ACTION:** Press the **"Buzzer"** button to turn the buzzer signal "off". If the reel is empty, press the **"Continue"** button, and then the **"MENU"** button, to bring up the "Reset" display. Press the **"Reset load"** button

to bring up the "Load, Unload, Menu" display and perform the standard reloading procedure (Refer to the *Reloading Procedure* section on Page 13). If this message appears, and it is apparent that the reel is not empty, then the tool was cycled without enough cable ties loaded, or a cable tie was prevented from leaving the dispenser. A cable tie will remain in the dispenser due to little or no air pressure, or an obstruction. In all cases, disconnect the air hose and feeder hose from the dispenser. If a cable tie is in the connector block, and it can be removed; do so. If a cable tie is not seen, contact your maintenance department to prevent further complications. After the cable tie is removed, reconnect the air hose and the feeder hose to the dispenser. Press the "**Continue**" button, and then the "**MENU**" button, to bring up the "Reset" display. Press the "**Reset load**" button to bring up the "Load, Unload, Menu" display. Press the "**Load**" button to load at least one cable tie into the dispenser. Continue system operation.

**PREVENTION:** To prevent this problem from recurring, verify that the air pressure is between 65 and 85 PSIG (4,5 and 5,8 bar), with a maximum 10 PSI (0,7 bar) drop.

### ERROR 2 - Cover is open, no tie loaded

Cover is open, no tie loaded			
Load	Unload	MENU	Buzzer

**POSSIBLE CAUSE:** This message will be displayed if the cover was open and the "Load" button was pressed or the tool was cycled.

**CORRECTIVE ACTION:** Press the "**Buzzer**" button to turn the buzzer signal "off". Close the cover. The rotary receiver will not advance unless the cover is closed. If the tool was cycled with the cover open, press the "**Load**" button to load one cable tie and resume operation. If the dispenser was being loaded, resume loading.

**PREVENTION:** Keep the cover closed.

### ERROR 3 - Check for low air pressure

Check for low air pressure			
Load	Unload	MENU	Buzzer

**POSSIBLE CAUSE:** This message will be displayed if the incoming air pressure is too low, or not connected.

**CORRECTIVE ACTION:** Press the "**Buzzer**" button to turn the buzzer signal "off". Increase the air pressure to 65 PSIG (4,5 bar).

**PREVENTION:** To prevent this problem from recurring, verify that the air line is connected, and the air pressure is between 65 and 85 PSIG (4,5 and 5,8 bar), with a maximum 10 PSI (0,7 bar) drop.

### ERROR 4 - Check for high air pressure

Check for high air pressure			
Load	Unload	MENU	Buzzer

**POSSIBLE CAUSE:** This message will be displayed if the incoming air pressure is too high.

**CORRECTIVE ACTION:** Press the "**Buzzer**" button to turn the buzzer signal "off". Decrease the air pressure to below 85 PSIG (5,8 bar).



**PREVENTION:** To prevent this problem from recurring, verify that the air pressure is between 65 and 85 PSIG (4,5 and 5,8 bar), with a maximum 10 PSI (0,7 bar) drop.

#### ERROR 5 - Dispenser jam - check tie loading

Dispenser jam - check tie loading			
Load	Unload	Buzzer	Continue

**POSSIBLE CAUSE:** This occurs if the dispenser rotary receiver is prevented from advancing (rotating) to the next position. This may be caused by a jam due to bowed or misaligned cable ties feeding into the rotary receiver, or a jam due to a backed-up cable tie carrier strip in the carrier strip exit chute.

**CORRECTIVE ACTION:** Press the "**Buzzer**" button to turn the buzzer signal "off". At this point, check the rotary receiver and connection block for misaligned or jammed cable ties, and check that the carrier strip scrap chute is clear. Press the "**Unload**" button to back the cable ties out until the jam and all remaining loose cable ties are cleared from the rotary receiver. Cut the excess carrier strip and any distorted or damaged cable ties from the cable tie strip. Close the dispenser cover and perform the normal loading procedure. If the rotary receiver will not unload, notify your Maintenance Department.

**PREVENTION:** To prevent this problem from recurring, load the dispenser with care to prevent misaligned cable ties in the rotary receiver, and empty the carrier strip scrap bin every 1/2 reel of cable ties.

#### ERROR 6 - Tie in tool

Tie in tool			
Help	Unload	Buzzer	Continue

**POSSIBLE CAUSE:** This occurs if the cable tie reaches the tool but is prevented from completing the cycle. This may be due to a large air pressure drop, too large of a bundle, improper feeder hose connections, an obstruction blocking the cable tie path, a severe bend or twist in the feeder hose, or the tool jaws are opened during the cycle.

**CORRECTIVE ACTION:** Remove the cable tie and any obstruction from the jaw area. Resume operation. If the problem continues, reverse the PHS feeder hose so the end that was connected to the PAT2S/PAT3S Tool is now connected to the PDS/PD3S Dispenser. Resume operation. If the problem continues, contact your Maintenance Department.

**PREVENTION:** To prevent this problem from recurring, verify that the feeder hose connections are secure and that there are no severe bends or twists in the feeder hose. Verify that the maximum bundle diameter does not exceed 2" (51 mm) for the PAT2S/PAT3S Tool. Also, verify that the air pressure is between 65 and 85 PSIG (4,5 and 5,8 bar), with a maximum 10 PSI (0,7 bar) drop.

#### ERROR 7 - Tie in hose -- press air burst

Tie in hose - press air burst		
Help	Air burst	Buzzer

**POSSIBLE CAUSE:** This occurs if a cable tie is caught or remains in the feeder hose upon actuation. This may be caused by a severe bend or twist in the feeder hose, low air pressure, or an interrupted cycle. When this occurs, the tool cannot be cycled until the cable tie is cleared from the hose.

**CORRECTIVE ACTION:** Press the "**Buzzer**" button to turn the buzzer signal "off". To clear the cable tie from the feeder hose, straighten the hose to eliminate any bends or twists and point the tool away from yourself and others. Press the "**Air burst**" button to provide a burst of air to dislodge and advance the cable tie to the jaw area of the

tool. The "**Air Burst**" button can be pressed again if the cable tie does not advance to the jaw area. When the cable tie is advanced to the tool jaw area, the "Tie in tool" message will appear and the buzzer will sound. Press the "**Buzzer**" button to turn the buzzer signal "off". Remove the cable tie from the jaw area and then press the "**Continue**" button. Press the "**Load**" button to load one cable tie into the dispenser and continue operation. (If "**Load**" does not appear, press the "**MENU**" button to bring up the "**Reset**" display. Press the "**Reset load**" button to bring up the "Load, Unload, Menu" display.) If the cable tie does not advance to the tool jaw area after depressing the "**Air Burst**" button several times, replace the feeder hose with another and notify your maintenance department.

**PREVENTION:** To prevent this problem from recurring, always prevent any severe bends or twists in the feeder hose, and verify that the air pressure is between 65 and 85 PSIG (4,5 and 5,8 bar), with a maximum 10 PSI (0,7 bar) drop.

### ERROR 8 - Blocked or dirty exit sensor

Blocked or dirty exit sensor			
Help	Air burst	Buzzer	Continue

**POSSIBLE CAUSE:** This will occur if the exit (optical) sensor in the PDS/PD3S Dispenser becomes obstructed due to a cable tie or excess debris (dirt, grime, etc.) on the lens. The cable tie will remain in the dispenser or the end of the PHS Feeder Hose that is attached to the dispenser. When this occurs, the tool cannot be actuated until the cable tie is cleared from the system or hose.

**CORRECTIVE ACTION:** Press the "**Buzzer**" button to turn the buzzer signal "off". Straighten the feeder hose to eliminate any bends or twists, and point the tool away from yourself and others. Press the "**Air burst**" button to provide a burst of air to dislodge and advance the cable tie to the jaw area of the tool. The "**Air Burst**" button can be pressed again if the cable tie does not advance to the jaw area. Remove the tie from the jaw area. If the cable tie does not advance to the jaw area after depressing the "**Air Burst**" several times, disconnect the PHS hose from the dispenser. Remove the cable tie sticking out of the dispenser by pulling lightly on it. Reconnect the hose to the dispenser. If the tie is stuck in the dispenser or there is no tie present, notify your Maintenance Department. If the error can be cleared, press the "**Continue**" button once the hose is reconnected to the dispenser. Press the "**Load**" button to load one cable tie into the dispenser and continue operation. (If "**Load**" does not appear, press the "**MENU**" button to bring up the "**Reset**" display. Press the "**Reset load**" button to bring up the "Load, Unload, Menu" display.)

**PREVENTION:** If this same error is repeated, the dispenser exit sensor lens may be cleaned with a cotton swab dampened with isopropyl alcohol. Disconnect the feeder hose from the dispenser and insert the dampened end of the cotton swab into the dispenser transfer tube about 1" (25 mm). Gently move the cotton swab in and out, against the top and bottom walls of the transfer tube, to clean the sensor.

### ERROR 9 - Blocked or dirty tool sensor

Blocked or dirty tool sensor		
Help	Air burst	Buzzer

**POSSIBLE CAUSE:** This will occur if the tool (optical) sensor in the tool becomes obstructed due to a cable tie or excess debris (dirt, grime, etc.) on the lens. The cable tie will remain in the tool or the end of the PHS Feeder Hose that is attached to the tool. When this occurs, the tool cannot be actuated until the cable tie is cleared from the tool or feeder hose.

**CORRECTIVE ACTION:** Press the "**Buzzer**" button to turn the buzzer signal "off". Disconnect feeder hose from tool. Look for cable tie in tool or tool end of hose and remove cable tie, if present. Reconnect feeder hose, and resume operation. Straighten the feeder hose to eliminate any bends or twists and point the tool away from yourself and others. Press the "**Air burst**" button to provide a burst of air to dislodge and advance the cable tie to

the jaw area of the tool. The **"Air Burst"** button can be pressed again if the cable tie does not advance to the jaw area. Remove the cable tie from the jaw area and then press the **"Continue"** button. Press the **"Load"** button to load one cable tie into the dispenser and continue operation. (If **"Load"** does not appear, press the **"Menu"** button to bring up the **"Reset"** display. Press the **"Reset load"** button to bring up the "Load, Unload, Menu" display.) If the cable tie does not advance to the tool jaw area after depressing the **"Air Burst"** button several times, or the tie is too difficult to remove, notify your maintenance department.

**PREVENTION:** If this same error is repeated, the tool sensor lens may require cleaning. Contact your maintenance department to have the tool sensor lens cleaned.

### ERROR 10 - Tie stuck in exit sensor

Tie stuck in exit sensor			
Help	Air burst	Buzzer	

**POSSIBLE CAUSE:** This will happen when the exit of the dispenser is blocked so that the cable tie cannot exit the dispenser. It may be blocked by a cable tie that was not removed from an earlier error, or from excess debris (dirt, grime, etc.) on the dispenser exit sensor lens. The cable tie has not exited the dispenser and must be removed before actuating the tool.

**CORRECTIVE ACTION:** Press the **"Buzzer"** button to turn the buzzer signal "off". Straighten the feeder hose to eliminate any bends or twists, and point the tool away from yourself and others. Press the **"Air burst"** button to provide a burst of air to dislodge and advance the cable tie to the jaw area of the tool. The **"Air Burst"** button can be pressed again if the cable tie does not advance to the jaw area. Remove the tie from the jaw area. If the cable tie does not advance to the jaw area after depressing the **"Air Burst"** several times, disconnect the PHS hose from the dispenser. Remove the cable tie sticking out of the dispenser by pulling lightly on it. Reconnect the hose to the dispenser. If the tie is stuck in the dispenser or there is no tie present, notify your Maintenance Department. If the error can be cleared, press the **"Continue"** button once the hose is reconnected to the dispenser. Press the **"Load"** button to load one cable tie into the dispenser and continue operation. (If **"Load"** does not appear, press the **"MENU"** button to bring up the **"Reset"** display. Press the **"Reset load"** button to bring up the "Load, Unload, Menu" display.)

**PREVENTION:** If this same error is repeated, the dispenser exit sensor lens may be cleaned with a cotton swab dampened with isopropyl alcohol. Disconnect the feeder hose from the dispenser and insert the dampened end of the cotton swab into the end of the strap tube about 1" (25 mm). Gently move the cotton swab in and out, against the top and bottom walls of the transfer tube, to clean the sensor.

### ERROR 11 - Tie stuck in tool sensor

Tie stuck in tool sensor			
Help	Air burst	Buzzer	Continue

**POSSIBLE CAUSE:** This message appears when the cable tie advances to the tool sensor area of the tool and remains there. When this occurs, the tool will not actuate again until the cable tie is cleared from the tool.

**CORRECTIVE ACTION:** Press the **"Buzzer"** button to turn the buzzer signal "off". Disconnect feeder hose from tool. Look for cable tie in tool or tool end of hose and remove cable tie, if present. Reconnect feeder hose, and resume operation. Straighten the feeder hose to eliminate any bends or twists and point the tool away from yourself and others. Press the **"Air burst"** button to provide a burst of air to dislodge and advance the cable tie to the jaw area of the tool. The **"Air Burst"** button can be pressed again if the cable tie does not advance to the jaw area. Remove the cable tie from the jaw area and then press the **"Continue"** button. Press the **"Load"** button to load one cable tie into the dispenser and continue operation. (If **"Load"** does not appear, press the **"Menu"** button to bring up the **"Reset"** display. Press the **"Reset load"** button to bring up the "Load, Unload, Menu" display.) If

the cable tie does not advance to the tool jaw area after depressing the "Air Burst" button several times, or the tie is too difficult to remove, notify your maintenance department.

**PREVENTION:** Always remove the cable tie from the jaw area of the tool if the cycle is not completed (cable tie did not wrap and tension around the bundle). Always have the air supply at the recommended pressure setting and avoid severe bends in the feeder hose.

### ERROR 12 - Detent sensor blocked or dirty

```
Detent sensor blocked or dirty
Help      Buzzer      Continue
```

**POSSIBLE CAUSE:** Most likely, the tip collector is too full. The detent sensor lens may be blocked by the detent cam, a foreign object, or the lens is dirty.

**CORRECTIVE ACTION:** Press the "Buzzer" button to turn the buzzer signal "off". Remove the cable tie from the jaw area of the tool and empty the tip collector. Press the "Continue" button and resume operation. If the error message appears again, notify your maintenance department.

**PREVENTION:** Always empty the tip collector before it is full (no more than 150 cycles). This will prevent debris from re-entering the tool because the tip collector is too full. Keeping the tip collector clear will allow the cable ties an area to exit the tool. The tool should also be cleaned periodically by your maintenance department.

### ERROR 13 - Internal regulator incorrectly set, low

```
Internal regulator incorrectly set, low
                                MENU      Buzzer
```

**POSSIBLE CAUSE:** This error message appears if the PDS/PD3S Dispenser internal regulator was adjusted incorrectly, or the dispenser piston is not fully shifting.

**CORRECTIVE ACTION:** Press the "Buzzer" button to turn the buzzer signal "off", and resume operation. If the message remains, the system will not operate. Write down the message and notify the maintenance department.

**PREVENTION:** Never adjust the PDS/PD3S Dispenser internal regulator. Follow the maintenance schedule for regreasing the piston.

### ERROR 14 - Internal regulator incorrectly set, high

```
Internal regulator incorrectly set, high
                                MENU      Buzzer
```

**POSSIBLE CAUSE:** This error message appears if the PDS/PD3S Dispenser internal regulator was adjusted incorrectly.

**CORRECTIVE ACTION:** Press the "Buzzer" button to turn the buzzer signal "off", and resume operation. If the message remains, the system will not operate. Write down the message and notify the maintenance department.

**PREVENTION:** Never adjust the PDS/PD3S Dispenser internal regulator.

## 7G: FUNCTIONAL MESSAGES

Functional messages notify the operator about component malfunction and/or maintenance requirements. Like the error messages, the operator is alerted that an error has occurred by two types of signals: a buzzer signal (audible) and the dispenser display (visual). The dispenser display will indicate the possible problem that has occurred. Depending on the nature of the problem, the system may not become operational until the system is serviced.

### Problem 1 - No exit sensor seen - service tool soon

No exit sensor seen - service tool soon		
MENU		Buzzer

**POSSIBLE CAUSE:** This message is displayed if there is a cable tie in the feeder hose at the time the tool is actuated (at the start of the cycle), or, if the dispenser exit sensor is not functioning properly.

**CORRECTIVE ACTION:** If this message appears, operation can be resumed immediately. If operation is resumed and the same message is displayed, the dispenser exit sensor may be dirty, or it may not be functioning properly.

**PREVENTION:** If this same error is repeated, the dispenser exit sensor lens may be cleaned with a cotton swab dampened with isopropyl alcohol. Disconnect the feeder hose from the dispenser and insert the dampened end of the cotton swab into the dispenser strap tube about 1.5" (38 mm) and gently move the cotton swab in and out, against the top and bottom walls of the strap tube. If the same error is repeated again, notify your maintenance department.

### Problem 2 - Switch #X is stuck or broken

Switch #X is stuck or broken
------------------------------

**POSSIBLE CAUSE:** This message will appear if a switch (button #1, 2, 3, 4, or the trigger) is held down or stuck when the dispenser is turned "on". This message will also appear if one of these five switches has malfunctioned. The specific switch (button) that was held down or that has malfunctioned will be displayed at the beginning of the message.

**CORRECTIVE ACTION:** When this occurs, the message will disappear when the switch (button #1, 2, 3, 4, or the trigger) has been freed or released. If the "Switch #X is stuck or broken" message does not disappear, then the specific switch (button #1, 2, 3, 4, or the trigger) is bad. Contact your maintenance department to have the switch replaced.

**PREVENTION:** To prevent this problem from recurring, do not press or hold down any switches (button #1, 2, 3, 4, or the trigger) when turning the dispenser power "on".

### Problem 3 - Restore past tool count

Restore past tool count?		
Mem Off	Yes	No

**POSSIBLE CAUSE:** This message may appear if the tool counter is no longer functioning.

**CORRECTIVE ACTION:** Press the "Yes" button and resume operation.

**PREVENTION:** If the same error is repeated, press the "Mem off" button and resume operation. Notify your maintenance department.

**Problem 4 - System error #X**

```
System error #X
Help           Mem Off           Continue
```

**POSSIBLE CAUSE:** There are 5 different functional messages that may appear. System error #1, #2, #3, #4, and #5 will appear if an internal electronic component malfunctions.

**CORRECTIVE ACTION:** For System errors #1 and #2, write down the system error number and notify your maintenance department immediately. For System errors #3, #4, and #5, toggle the power switch (turn the power "off" and then back "on" again) to reset the system. If the message disappears, resume operation. If the message still appears, press the "**Continue**" button and resume operation. If the System error message does not disappear, do not resume operation. Write down the system error number and notify your maintenance department immediately.

**PREVENTION:** None.

**7H: STATUS MESSAGES**

Status messages are displayed as the dispenser performs self-diagnoses. No action is required on the part of the operator other than notifying the maintenance department of the status message.

**STATUS 1 - Calibrate line pressure sensor**

```
Panduit
Calibrate line pressure sensor
```

**STATUS 2 - Calibrate back pressure sensor**

```
Panduit
Calibrate back pressure sensor
```

**STATUS 3 - Reset EEPROM**

```
Reset EEPROM
```

**STATUS 4 - Reset dispenser RAM**

```
Reset dispenser RAM
```

**STATUS 5 - Reset tool RAM**



```
Reset tool RAM
```

**8: MAINTENANCE****8A: DAILY PREVENTIVE MAINTENANCE**

The following maintenance of the PAT2S/PAT3S System must be performed daily (as needed) to ensure optimum performance and trouble-free operation of the PAT2S/PAT3S System.

INTERVAL	MAINTENANCE PROCEDURE
No more than 150 cycles	<b>Empty tip collector before full.</b> (Refer to Tip Collector section on Page 18.)
No more than 2500 cycles (= 1 cable tie reel)	<b>Empty carrier strip scrap bin.</b> (Refer to Reloading Procedure on Page 13)

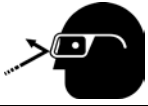
**8B: EXTENDED MAINTENANCE**

	<b>CAUTION: SAFETY GLASSES WITH SIDE SHIELDS MUST BE WORN AT ALL TIMES DURING THE MAINTENANCE OR ADJUSTMENT OF THE PAT2S/PAT3S TOOLS.</b>
	<b>CAUTION: ALWAYS DISCONNECT AIR SUPPLY FROM TOOL <u>BEFORE</u> DISASSEMBLY.</b>
	<b>CAUTION: ELECTROSTATIC SENSITIVE DEVICE. DO NOT OPEN OR HANDLE EXCEPT AT A STATIC FREE WORK STATION.</b>

The following maintenance of the PAT2S/PAT3S System must be completed within the recommended intervals to ensure trouble-free operation and longevity of the PAT2S/PAT3S System. Certain extended maintenance procedures must be performed by your maintenance department. Please notify your maintenance department when these specific maintenance intervals are reached. Refer to the Maintenance and Repair Manual for the PAT2S/PAT3S System for detailed maintenance procedures.

INTERVAL	UNIT	MAINTENANCE PROCEDURE	LUBRICANT
Every 50 000 cycles <sup>1</sup>	PAT2S/PAT3S	<b>Clean tool housings and gears of debris.</b> (Maintenance dept. must perform this procedure.)	N/A
		<b>Regrease Detent Cam Follower.</b> (Maintenance dept. must perform this procedure.)	Schaeffer's Moly Ultra 800 EP
Every 250 000 cycles <sup>2</sup>	PAT2S/PAT3S	<b>Clean and regrease all pivots and shafts.</b> (Maintenance dept. must perform this procedure.)	Schaeffer's Moly Ultra 800 EP
	PDS/PD3S	<b>Clean and relubricate Piston and Piston Sleeve in Connection Block.</b> (Maintenance dept. must perform this procedure.)	Parker O-Lube Panduit Part # WT24102A01
Every 1 million cycles <sup>3</sup>	PAT2S/PAT3S	<b>Clean Tool Sensor Lens.</b> (Refer to Cleaning the Tool Sensor Lens below.)	N/A
	PDS/PD3S	<b>Clean Exit Sensor Lens.</b> (Refer to Cleaning the Exit Sensor Lens below.)	N/A
	PDS/PD3S	<b>Clean and relubricate Piston and Piston Sleeve in Connection Block. Replace Piston O-Rings.</b> (Maintenance dept. must perform this procedure.)	Parker O-Lube Panduit Part # WT24102A01
Every 2 million cycles <sup>4</sup>	PDS/PD3S	<b>Clean and regrease Carrier Hub Bearing.</b> (Maintenance dept. must perform this procedure.)	GE Versilube

<sup>1</sup> Every 20 cable tie reels; <sup>2</sup> Every 100 cable tie reels; <sup>3</sup> Every 400 cable tie reels; <sup>4</sup> Every 800 cable tie reels

### **8C: CLEANING THE TOOL SENSOR LENS**

Disconnect the PHS Feeder Hose from the PAT2S/PAT3S Tool. Dampen one end of a cotton swab with isopropyl alcohol and insert the dampened end of the cotton swab into the end of the transfer tube about 1" (25 mm) and gently move the cotton swab in and out, against the top and bottom walls of the transfer tube until clean. Reconnect PHS Feeder Hose to PAT2S/PAT3S Tool and resume operation.

### **8D: CLEANING THE EXIT SENSOR LENS**

Disconnect the PHS Feeder Hose from the PDS/PD3S Dispenser. Dampen one end of a cotton swab with isopropyl alcohol and insert the dampened end of the cotton swab into the end of the transfer tube about 1" (25 mm) and gently move the cotton swab in and out, against the top and bottom walls of the transfer tube until clean. Reconnect PHS Feeder Hose to PDS/PD3S Dispenser and resume operation.





**10: TROUBLESHOOTING****10A: ERROR MESSAGES TROUBLESHOOTING CHECKLIST**

MESSAGE	POSSIBLE CAUSE	CORRECTIVE ACTION
Out of ties or tie in dispenser	<p>A. Reel empty; dispenser has run out of cable ties.</p> <p>B. Reel not empty; tool cycled without enough cable ties loaded, or cable tie prevented from leaving dispenser.</p>	<p>A. 1. Press "Buzzer" button to turn buzzer "off". 2. Press "Continue" button and then the "Menu" button to bring up the "Reset" display. 3. Press "Reset load" button to bring up the "Load, Unload, Menu" display and perform the standard reloading procedure.</p> <p>B. 1. Disconnect air hose and feeder hose from dispenser. 2. Remove cable tie from connector block, if present. If not, notify your maintenance department. 3. After cable tie is removed, reconnect air hose and feeder hose to dispenser. 4. Press "Continue" button and then the "Menu" button to bring up the "Reset" display. 5. Press "Reset load" button to bring up the "Load, Unload, Menu" display. 6. Press "Load" button to load one (1) cable tie and resume operation.</p>
Cover is open, no tie loaded	<p>A. Cover was open when "Load" button was pressed.</p> <p>B. Cover was open when tool was cycled.</p>	<p>A. 1. Press "Buzzer" button to turn buzzer "off". 2. Close and latch the cover. 3. Resume loading procedure.</p> <p>B. 1. Press "Buzzer" button to turn buzzer "off". 2. Close and latch the cover. 3. Press "Load" button to load one (1) cable tie and resume operation.</p>
Check for low air pressure	<p>A. Incoming air pressure is too low or not connected.</p> <p>B. Air is not connected to dispenser.</p>	<p>A. 1. Press "Buzzer" button to turn buzzer "off". 2. Set air pressure between 65 and 85 PSIG (4,5 and 5,8 bar), with a maximum 10 PSI (0,7 bar) drop.</p> <p>B. Connect air to dispenser.</p>
Check for high air pressure	Incoming air pressure is too high.	<p>1. Press "Buzzer" button to turn buzzer "off".</p> <p>2. Set air pressure between 65 and 85 PSIG (4,5 and 5,8 bar), with a maximum 10 PSI (0,7 bar) drop.</p>
Dispenser jam - check tie loading	Dispenser rotary receiver did not advance (rotate) to the next position due to bowed or misaligned cable ties feeding into the rotary receiver, or due to a backed-up cable tie carrier strip in the carrier strip exit chute, or cable tie reel moved off of reel pivot disk on dispenser frame.	<p>1. Press "Buzzer" button to turn buzzer "off".</p> <p>2. Check the rotary receiver and connection block for misaligned or jammed cable ties, and check that the carrier strip exit chute is clear.</p> <p>3. Press "Unload" button to back the cable ties out until the jam and all remaining loose cable ties are cleared from the rotary receiver.</p> <p>4. Cut the excess carrier strip and any distorted or damaged cable ties from the cable tie strip.</p> <p>5. Close the dispenser cover and perform the standard loading procedure.</p>
Tie in tool	Cable tie reaches the tool but is prevented from completing the cycle due to a large air pressure drop, too large of a bundle, improper feeder hose connections, an obstruction blocking the cable tie path, a severe bend or twist in the feeder hose, or the tool jaws are opened during the cycle.	<p>1. Press "Buzzer" button to turn buzzer "off".</p> <p>2. Remove cable tie and any obstruction from the jaw area.</p> <p>3. Press the "Continue" button to resume operation.</p> <p>4. Correct any conditions that prevent the cable tie cycle from being completed.</p>

MESSAGE	POSSIBLE CAUSE	CORRECTIVE ACTION
Tie in hose - press air burst	Cable tie is caught or remains in feeder hose upon actuation due to a severe bend or twist in the feeder hose, low air pressure, or an interrupted cycle.	<ol style="list-style-type: none"> <li>1. Press "Buzzer" button to turn buzzer "off".</li> <li>2. Straighten feeder hose to eliminate any bends or twists, and point tool away from yourself and others.</li> <li>3. Press "Air burst" button to dislodge and advance cable tie to jaw area of tool. Press several times, if necessary. When cable tie is advanced to jaw area, "Tie in tool" message will appear and buzzer will sound.</li> <li>4. Press "Buzzer" button to turn buzzer "off".</li> <li>5. Remove cable tie from jaw area and press the "Continue" button.</li> <li>6. Press "Load" button to load one (1) cable tie and resume operation.</li> <li>7. If the cable tie does not advance to the tool jaw area after depressing the "Air Burst" button several times, replace the feeder hose with another and notify your maintenance department.</li> </ol>
Blocked or dirty exit sensor	Exit (optical) sensor in the dispenser is obstructed due to a cable tie or excess debris (dirt, grime).	<ol style="list-style-type: none"> <li>1. Press "Buzzer" button to turn buzzer "off".</li> <li>2. Disconnect feeder hose from dispenser. Look for cable tie in dispenser connector block and remove cable tie, if present.* Reconnect feeder hose, and resume operation. Follow the same Corrective Action for "Tie in hose - press air burst" error to remove the cable tie from the system.</li> <li>3. If the same error is repeated, clean the dispenser exit sensor lens (Refer to the <i>Cleaning the Dispenser Exit Sensor Lens</i> section on Page 28).</li> </ol>
Blocked or dirty tool sensor	Tool (optical) sensor is obstructed due to a cable tie or excess debris (dirt, grime).	<ol style="list-style-type: none"> <li>1. Press "Buzzer" button to turn buzzer "off".</li> <li>2. Disconnect feeder hose from tool. Look for cable tie in tool or tool end of hose and remove cable tie, if present. Reconnect feeder hose, and resume operation. Follow the same Corrective Action for "Tie in hose - press air burst" error to remove the cable tie from the system.</li> <li>3. If the same error is repeated, the tool sensor lens may require cleaning. Contact your maintenance department to have the tool sensor lens cleaned.</li> </ol>
Tie stuck in exit sensor	The dispenser exit sensor in is blocked so that a cable tie cannot exit the dispenser. It may be blocked by another cable tie that was not removed from an earlier cycle.	<ol style="list-style-type: none"> <li>1. Press "Buzzer" button to turn buzzer "off".</li> <li>2. Disconnect air hose and feeder hose from dispenser. Look for cable tie in dispenser connector block and remove cable tie, if present.* Reconnect air hose and feeder hose, and resume operation. Follow the same Corrective Action for "Tie in hose -press air burst" error to remove the cable tie from the system.</li> <li>3. If the same error is repeated, clean the dispenser exit sensor lens (Refer to the <i>Cleaning the Dispenser Exit Sensor Lens</i> section on Page 28).</li> </ol>
Tie stuck in tool sensor	Cable tie has stopped in the tool sensor area of tool.	<ol style="list-style-type: none"> <li>1. Press "Buzzer" button to turn buzzer "off".</li> <li>2. Follow corrective action for "Blocked or dirty tool sensor" error above.</li> </ol>
Detent sensor blocked or dirty	Tip collector full. Detent sensor blocked by detent cam, foreign object, or detent sensor lens is dirty.	<ol style="list-style-type: none"> <li>1. Press "Buzzer" button to turn buzzer "off".</li> <li>2. Remove cable tie from jaw area of tool.</li> <li>3. Press the "Continue" button and resume operation.</li> <li>4. If message reappears, notify maintenance department.</li> </ol>
Internal regulator incorrectly set, low	Internal regulator was adjusted incorrectly, or the piston is not fully shifting.	<ol style="list-style-type: none"> <li>1. Press "Buzzer" button to turn buzzer 'off' and resume operation.</li> <li>2. If message remains, system will not operate. Write down message and notify maintenance department.</li> </ol>
Internal regulator incorrectly set, high	Internal regulator was adjusted incorrectly.	

\*If the cable tie does not come out freely, turn the dispenser "off" and then "on" again, to reset the rotary receiver's position.

**10B: FUNCTIONAL MESSAGE TROUBLESHOOTING**

MESSAGE	POSSIBLE CAUSE	CORRECTIVE ACTION
No exit sensor seen - service tool soon	Cable tie in feeder hose when tool was actuated or dispenser exit sensor is not functioning properly.	<ol style="list-style-type: none"> <li>Resume operation.</li> <li>If the same error is repeated, the exit sensor lens may be dirty, or it may not be functioning properly.</li> <li>Clean the exit sensor lens (Refer to the <i>Cleaning the Dispenser Exit Sensor Lens</i> section on Page 28).</li> <li>If the same error is repeated, notify your maintenance department.</li> </ol>
Switch #X is stuck or broken	A switch (button #1, 2, 3, 4, or the trigger) was held down or was stuck when the dispenser was turned "on". This message will remain if one of these five switches has malfunctioned.	<ol style="list-style-type: none"> <li>The message will disappear when the switch (button #1, 2, 3, 4, or the trigger) has been freed or released.</li> <li>If the message does not disappear, then the specific switch (button #1, 2, 3, 4, or the trigger) is bad. Contact your maintenance department to have the switch replaced.</li> </ol>
Restore past tool count?	Tool counter is not functioning correctly.	<ol style="list-style-type: none"> <li>Press the "Yes" button and resume operation.</li> <li>If the same error is repeated, notify your maintenance department.</li> </ol>
System error #X	See Page 26.	See Page 26.

**10C: CABLE TIE INSTALLATION TROUBLESHOOTING**

SYMPTOM	POSSIBLE CAUSE	CORRECTIVE ACTION
Cable tie too loose on bundle.	<ol style="list-style-type: none"> <li>Tool tension setting is too low.</li> <li>Operator holding tool at angle to bundle.</li> <li>Bundle exceeds 2" (51 mm) in diameter.</li> <li>Tool is held away from bundle by previously installed tie, harness support, or other object on bundle.</li> <li>Tool is pulled on as the tie is being tensioned.</li> </ol>	<ol style="list-style-type: none"> <li>Increase tool tension setting.</li> <li>Hold tool perpendicular to bundle in both directions.</li> <li>Dress the wires to result in a more compact bundle for the specific tool being used.</li> <li>Do not install cable ties too close to other cable ties, harness supports or other objects on bundle.</li> <li>Allow tool to seek its own position as the tie is being tensioned.</li> </ol>
Cable tie too tight on bundle.	Tool tension setting is too high.	Decrease tool tension setting.
Cable tie not cut off flush to head.	<ol style="list-style-type: none"> <li>Tool tension setting too high for humidity conditions.</li> <li>Operator holding tool at angle to bundle.</li> <li>Tool is pulled on as the tie is being tensioned.</li> <li>Tool is held away from bundle by previously installed tie, harness support or other object on bundle.</li> </ol>	<ol style="list-style-type: none"> <li>Decrease tool tension setting.</li> <li>Hold tool perpendicular to bundle in both directions.</li> <li>Allow tool to seek its own position as the tie is being tensioned.</li> <li>Do not install cable ties too close to other cable ties, harness supports or other objects on bundle.</li> </ol>
Cable tie does not stay on bundle.	<ol style="list-style-type: none"> <li>Bundle exceeds 2" (51 mm) in diameter.</li> <li>Cable ties are too dry and brittle.</li> <li>Tool tension setting is too high.</li> <li>Incoming air pressure is too high.</li> </ol>	<ol style="list-style-type: none"> <li>Dress the wires to result in a more compact bundle for the specific tool being used.</li> <li>Store cable ties properly and use before expiration date.</li> <li>Decrease tool tension setting.</li> <li>Set air pressure between 65 and 85 PSIG (4,5 and 5,8 bar), with a maximum 10 PSI (0,7 bar) drop.</li> </ol>
Misfeed; cable tie cycle was not completed	<ol style="list-style-type: none"> <li>Cable tie path was blocked; bundle against jaw tie track.</li> <li>Air pressure is not set correctly.</li> </ol>	<ol style="list-style-type: none"> <li>DO NOT place bundle forcefully against jaw tie track.</li> <li>Verify that air pressure is at 65 PSIG (4,5 bar) (minimum). Air pressure can be increased by 5 PSI (0,35 bar) increments until cable ties feed properly. Do not exceed 85 PSIG (5,8 bar) (maximum).</li> </ol>

## 11: "QUICK REFERENCE" MENUS

### 11A: OPERATOR MENUS

#### OPENING MENU

Panduit	rX.X
Tool is ready	

Appears for 5 seconds

#### LEVEL 1 - Operator Menu ("Load, Unload, Menu" Display)

Loads:14	XXXXXXXX
Load	Unload MENU

BUTTON 1 - Loads one cable tie  
 BUTTON 2 - Unloads one cable tie  
 BUTTON 3 - Brings up LEVEL 2  
 BUTTON 4 - Inactive

#### LEVEL 1B – Loading commands disappear

XXXXXXXX
MENU

Appears after tool is actuated one or more times

#### LEVEL 2 - Load and Counter Reset Menu ("Reset" Display)

Resets load and/or counter		
Reset Ld	Reset Ct	Exit

BUTTON 1 - Resets Load counter  
 BUTTON 2 - Resets install. tie counter  
 BUTTON 3 - Inactive  
 BUTTON 4 - Returns to LEVEL 1

### 11B: SETUP MENUS

#### LEVEL 2 - SETUP MENU ACCESS

Resets load and/or counter		
Reset Ld	Reset Ct	Exit

1. Press BUTTON 3, two times
2. Press BUTTON 1, one time
3. Brings up LEVEL 3

#### LEVEL 3 - Total Counts Menu

Shows total counts			
Counters	Escape	MENU	Exit

BUTTON 1 - Brings up LEVEL 3A  
 BUTTON 2 - Returns to LEVEL 1 or 1B  
 BUTTON 3 - Brings up LEVEL 4  
 BUTTON 4 - Returns to LEVEL 2

#### LEVEL 3A - Dispenser and Tool Counts

PDS/PD3S	#	XXXXXX	Rev X.X	Cycles: XXXXXXXX
PAT2S/PAT3S	#	XXXXXX		Cycles: XXXXXXXX

BUTTON 1 - Inactive  
 BUTTON 2 - Inactive  
 BUTTON 3 - Inactive  
 BUTTON 4 - Returns to LEVEL 3

#### LEVEL 4 - Chopper Cut Cycle Menu

Turn chopper on/off			
Chopper	Escape	MENU	Exit

BUTTON 1 - Brings up LEVEL 4A  
 BUTTON 2 - Returns to LEVEL 1 or 1B  
 BUTTON 3 - Brings up LEVEL 5  
 BUTTON 4 - Returns to LEVEL 3

**LEVEL 4A - Current Chopper Cutting Cycle**

Chopper is - On		
On	Off	Exit

BUTTON 1 - Turns chopper "on"  
 BUTTON 2 - Turns chopper "off"  
 BUTTON 3 - Inactive  
 BUTTON 4 - Returns to LEVEL 4

**LEVEL 5 - Line Pressure Menu**

View line pressure			
Pressure	Escape	Menu	Exit

BUTTON 1 - Brings up LEVEL 5A  
 BUTTON 2 - Returns to LEVEL 1 or 1B  
 BUTTON 3 - Brings up LEVEL 6  
 BUTTON 4 - Returns to LEVEL 4

**LEVEL 5A - Min./Max. Pressure Readings**

XX PSI	MIN: XX PSI	MAX: XX PSI
BAR/PSI	Clear	Exit

BUTTON 1 - Select unit of measure  
 BUTTON 2 - Clears present readings  
 BUTTON 3 - Inactive  
 BUTTON 4 - Returns to LEVEL 5

**LEVEL 6 - Language Menu**

Set language		
Language	Escape	Exit

BUTTON 1 - Brings up LEVEL 6A  
 BUTTON 2 - Returns to LEVEL 1 or 1B  
 BUTTON 3 - Inactive  
 BUTTON 4 - Returns to LEVEL 5

**LEVEL 6A - Current Language Selected**

English		
↑	↓	Select

BUTTON 1 - Scrolls "UP"  
 BUTTON 2 - Scrolls "DOWN"  
 BUTTON 3 - Inactive  
 BUTTON 4 - Select/Return to LEVEL 6



**MENU LANGUAGE CHOICES:**

English, Deutsch (German), Française (French), Italiana (Italian), Español (Spanish), Ěeský (Czech), Danske (Danish), Svenska (Swedish), and Suomen (Finish).

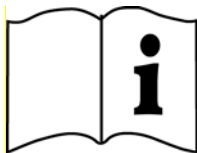

**OPERATION MANUAL  
LANGUAGE CHOICES:**

English, Deutsch (German), Française (French), Italiana (Italian), Español (Spanish), Nederlandse (Dutch), Suomen (Finish) and Norsk (Norwegian).

**11C: CABLE TIE CONDITION FACTORS**

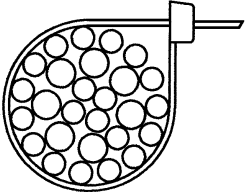
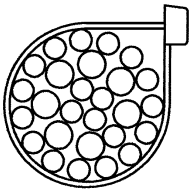
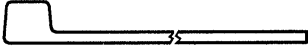
		
<p><b>INCORRECT CABLE TIE CUT-OFF (Long cut-off / tail)</b></p> <ul style="list-style-type: none"> <li>• <b>Cable ties are too moist (due to high humidity)</b></li> <li>- Turn down tension until correct cut-off occurs.</li> </ul>	<p><b>CORRECT CABLE TIE CUT-OFF</b></p>	<p><b>CABLE TIE DETACHES FROM BUNDLE</b></p> <ul style="list-style-type: none"> <li>• <b>Cable ties are too brittle (due to dry conditions)</b></li> <li>- Take new reel of ties out of original bag.</li> <li>- Place new ties on PDS/PD3S</li> <li>- Place used reel in bag with damp paper towel or sponge to recondition.</li> </ul>