

HD Flex Cassette mounting bracket for one 6-port cassette in Network Zone
ZFLEX1

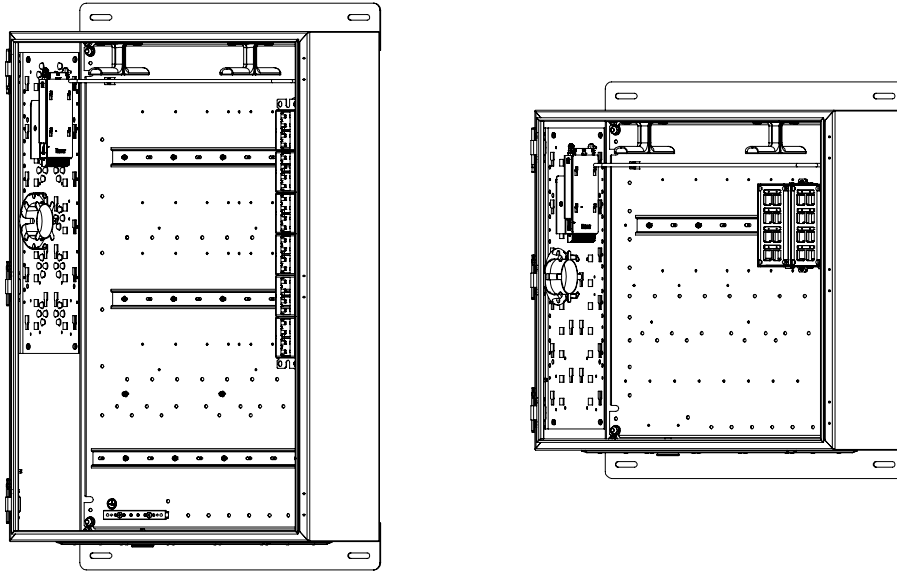

HD Flex Cassette mounting bracket for two 6-port cassettes in Network Zone
ZFLEX2

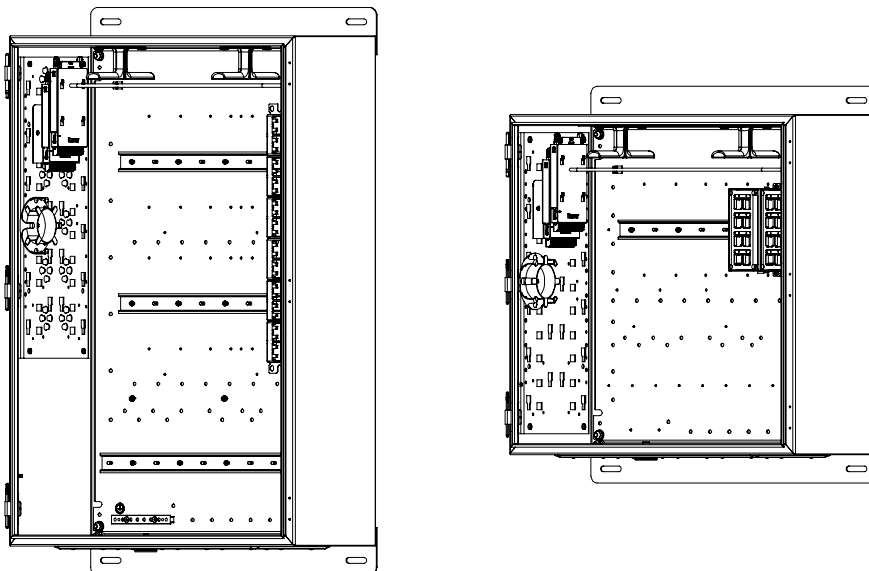

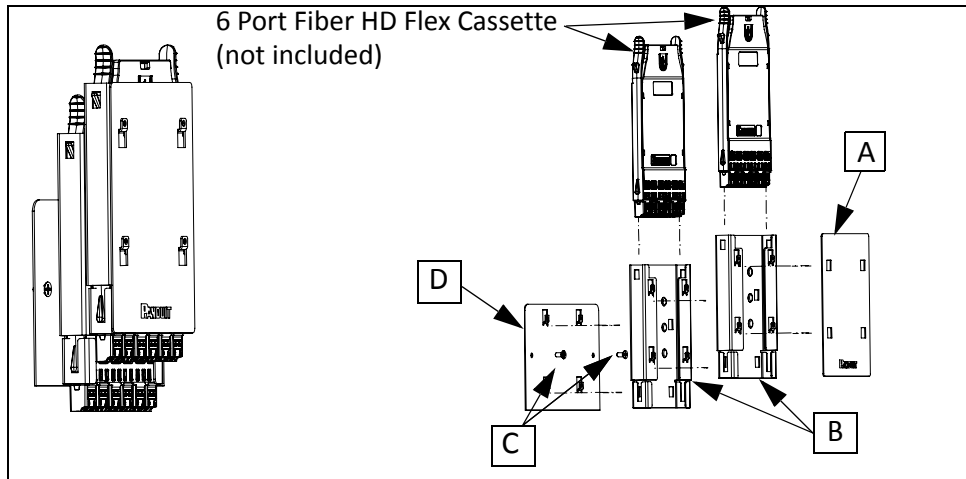

HD Flex Cassette mounting bracket components may include one or more of the following items:

- A) Stack Bracket Cover
- B) Enclosure Stack Bracket
- C) #6-32 x 5/16" Screws
- D) Enclosure Stack Base

*6-Port Fiber HD Flex Cassette is shown, for information only and is not included.

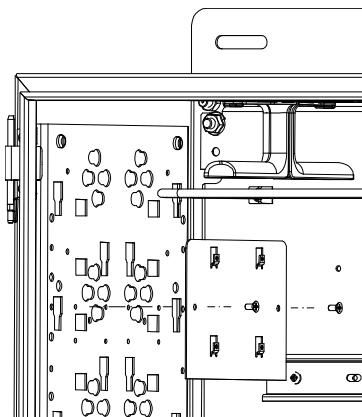

Curved edges are top of plate.

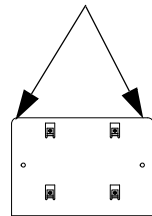

Mounting The Stack Base

Step 1: Locate holes in wall of enclosure that are 5.0" apart at .1359 diameter.

Step 2: Install Enclosure Stack Base on wall of enclosure using (2) #6-32 x 5/16" screw and torque spec 5.0 in-lbs.

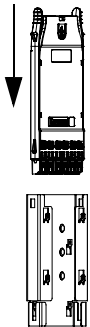

Install Fiber HD Flex Cassette

Step 3: Insert a 6-Port Fiber Cassette (not included) into Enclosure Stack Bracket. Slide down into top of Enclosure Stack Bracket until it snaps in place.

Attach Bracket To Base

Step 4A: Attach Enclosure Stack Bracket to Enclosure Stack Base.
Insert 4 open holes in back of Enclosure Stack Bracket into the 4 tabs of the Enclosure Stack Base and slide down to attach.

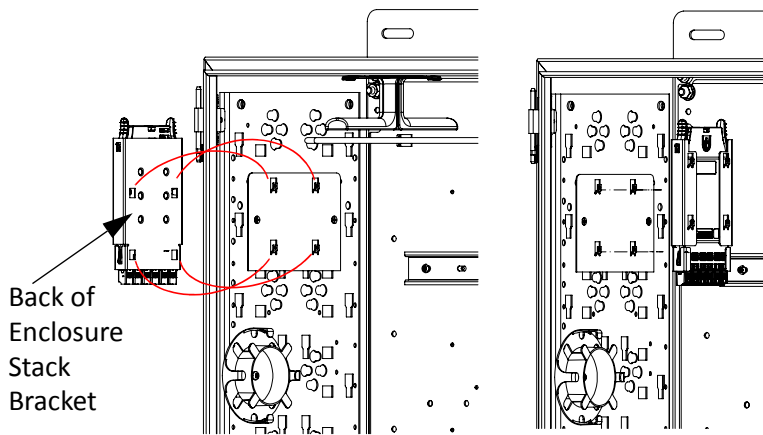

Step 4B: Enclosure Stack Bracket now attached to Enclosure Stack Base.

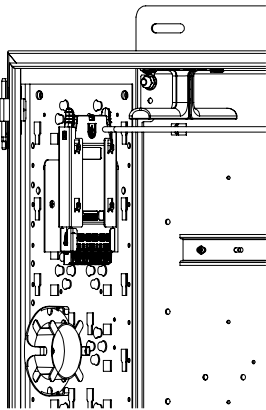

Step 5: Repeat Steps 4A and 4B for 12 Port Fiber Cassette.

Step 6: Install Stack Bracket Cover.
Insert 4 open holes of Stack Bracket Cover into the 4 tabs of Enclosure Stack Bracket and slide down to attach.

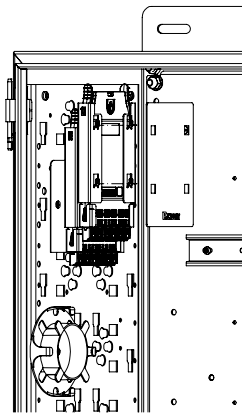

Step 7: Fiber HD Flex Cassette Installation is complete

