

THIS COPY IS PROVIDED ON A RESTRICTED BASIS AND IS NOT TO BE USED IN ANY WAY DETRIMENTAL TO THE INTERESTS OF PANDUIT CORP.

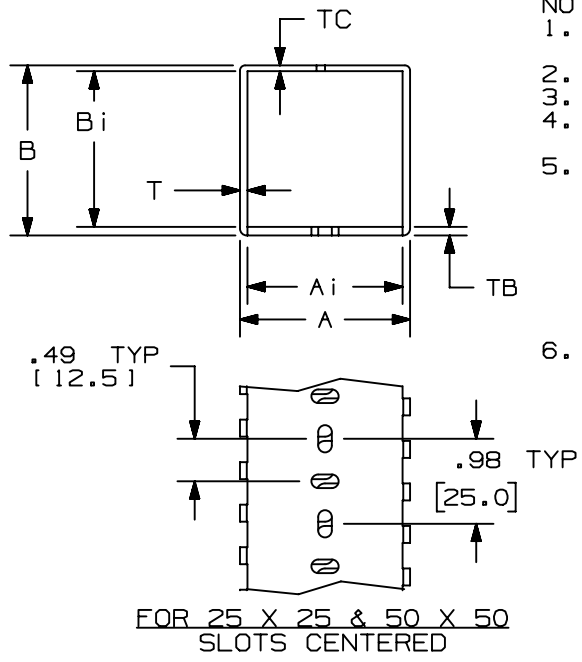

- NOTES:
1. DIMENSIONS IN PARENTHESES ARE IN METRIC.
 2. COLOR: LIGHT GREY
 3. "TA" DIMENSION IS REFERENCE ONLY.
 4. MOUNTING HOLE SLOT DIMENSIONS: .16 (4.0) X .31 (8.0) - TYP.
 5. NO WARRANTY, EXPRESSED OR IMPLIED, IS MADE BY PANDUIT WITH THE RESPECT TO ADHESIVE BOND PERFORMANCE. AMONG OTHER THINGS, THE CONDITIONS UNDER WHICH THESE DUCTS MAY BE APPLIED AND/OR THE SURFACE TO WHICH THEY MAY BE APPLIED ARE BEYOND PANDUIT'S CONTROL.
 6. ONE COMPLETE MOUNTING HOLE ON BOTH ENDS OF DUCT WILL NOT BE COVERED BY TAPE.

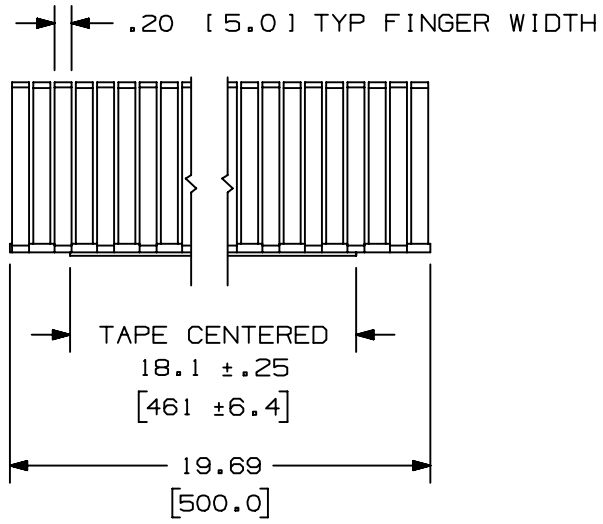
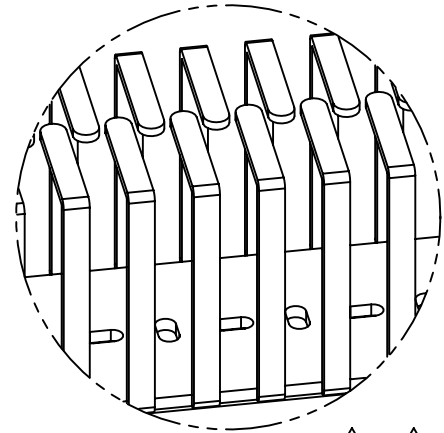
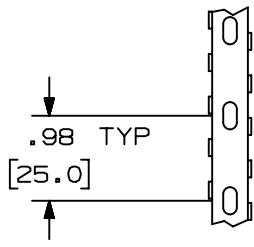
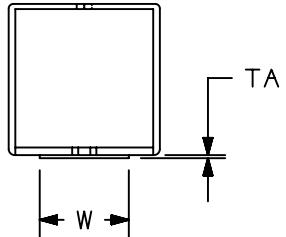
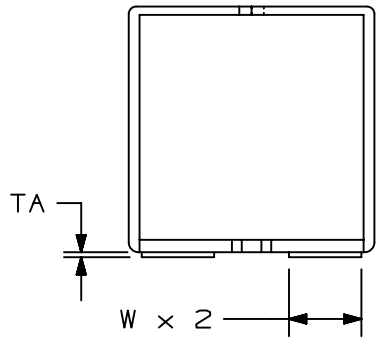

FL50X50LG: -A; -AV
2 STRIPS OF TAPE (R)

FL12X12LG: -A; -AV &
FL25X25LG: -A; -AV (R)
TAPE CENTERED

FOR 12 X 12
SLOTS CENTERED

(Q) (P)

TITLE		FLEXIBLE DUCT SIZES: 12mm, 25mm, 50mm CUSTOMER DRAWING		
ITEM REVISION NAME		D38086BC/11		
DATASET FILE NAME		D38086BC_DC/11A		
UNLESS OTHERWISE SPECIFIED, DIMENSIONAL TOLERANCES ARE: IN (mm)		MATERIAL: POLYPROPYLENE		
.X ± .XXX ± .XX ± .02 [.5]		ANGLES ±		
DRAWN BY: JCST		DATE: 04-10-01		DRAWING NUMBER: 38086-03
CHK: JKG		SCALE: NONE		SHT 1 OF 2
THIRD ANGLE PROJECTION		SIZE: A		

REV	DATE	BY	CHK	APR	DESCRIPTION	ECN
11A	03.01.21	BDK	MRJS	JADE	R. ADDED PART NUMBERS "FL12X12LG; FL25X25LG; FL50X50LG; FL12X12LG-AV; FL25X25LG-AV; FL50X50LG-AV"	101297
10	03-09-15	JBN	MRJS	RGRO	Q. REVISED DIMENSIONS AND TOLERANCES	38086-03
9	02-26-13	JBN	RTFI	RTFI	P. UPDATED DRAWING BORDER & TITLE BLOCK	38086-03

THIS COPY IS PROVIDED ON A RESTRICTED BASIS AND IS NOT TO BE USED IN ANY WAY DETRIMENTAL TO THE INTERESTS OF PANDUIT CORP.

PANDUIT P/N	A X B ± .04 [1.0]	Ai x Bi ± .04 [1.0]	T	TB	TC	T, TB, TC TOLERANCES	TAPE QTY. W X TA	WEIGHT	PKG. QTY.
	FL12X12LG	.49 X .49 [12.5 X 12.5]	.40 x .40 [10.3 x 10.6]	.04 [1.0]	.04 [1.1]	.04 [0.9]	± .006 [.15]	N/A N/A	0.02 lb/ea [10.8 g/ea]
FL25X25LG	.98 X .98 [25.0 X 25.0]	.90 x .90 [21.8 x 22.3]	.06 [1.5]	.06 [1.6]	.05 [1.2]	± .015 [.38]	N/A N/A	0.07 lb/ea [31.7 g/ea]	70
FL50X50LG	1.97 X 1.97 [50.0 X 50.0]	1.80 x 1.80 [45.0 x 45.0]	.09 [2.2]	.10 [2.5]	.07 [1.7]	± .025 [.64]	N/A N/A	0.21 lb/ea [96.6 g/ea]	32
FL12X12LG-A	.49 X .49 [12.5 X 12.5]	.40 x .40 [10.3 x 10.6]	.04 [1.0]	.04 [1.1]	.04 [0.9]	± .006 [.15]	1 .24 [6.1] X .04 [1.0]	0.03 lb/ea [12.3 g/ea]	112
FL25X25LG-A	.98 X .98 [25.0 X 25.0]	.90 x .90 [21.8 x 22.3]	.06 [1.5]	.06 [1.6]	.05 [1.2]	± .015 [.38]	1 .58 [14.7] X .04 [1.0]	0.07 lb/ea [33.3 g/ea]	70
FL50X50LG-A	1.97 X 1.97 [50.0 X 50.0]	1.80 x 1.80 [45.0 x 45.0]	.09 [2.2]	.10 [2.5]	.07 [1.7]	± .025 [.64]	2 .58 [14.7] X .04 [1.0]	0.23 lb/ea [103.3 g/ea]	32
FL12X12LG-AV	.49 X .49 [12.5 X 12.5]	.40 x .40 [10.3 x 10.6]	.04 [1.0]	.04 [1.1]	.04 [0.9]	± .006 [.15]	1 .24 [6.1] X .025 [0.6]	0.03 lb/ea [12.6 g/ea]	112
FL25X25LG-AV	.98 X .98 [25.0 X 25.0]	.90 x .90 [21.8 x 22.3]	.06 [1.5]	.06 [1.6]	.05 [1.2]	± .015 [.38]	1 .58 [14.7] X .025 [0.6]	0.08 lb/ea [35.4 g/ea]	70
FL50X50LG-AV	1.97 X 1.97 [50.0 X 50.0]	1.80 x 1.80 [45.0 x 45.0]	.09 [2.2]	.10 [2.5]	.07 [1.7]	± .025 [.64]	2 .58 [14.7] X .025 [0.6]	0.23 lb/ea [105.4 g/ea]	32

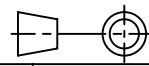
REV	DATE	BY	CHK	APR	DESCRIPTION	ECN	TITLE	MATERIAL	DRAWING NUMBER			
							FLEXIBLE DUCT SIZES: 12mm, 25mm, 50mm CUSTOMER DRAWING	POLYPROPYLENE	38086-03			
							ITEM REVISION NAME D38086BC/11					
							DATASET FILE NAME D38086BC_DC/11A					
11A	03.01.21	BDK	MRJS	JADE	SEE SHEET 1 FOR DESCRIPTION OF CHANGES	101297	UNLESS OTHERWISE SPECIFIED, DIMENSIONAL TOLERANCES ARE: IN [mm] .X ± .02 [.5] ANGLES ±					
10	03-09-15	JBN	MRJS	RTFI	SEE SHEET 1 FOR DESCRIPTION OF CHANGES	38086-03	 THIRD ANGLE PROJECTION					
9	02-26-13	JBN	RTFI	RTFI	SEE SHEET 1 FOR DESCRIPTION OF CHANGES	38086-03						
							DRAWN BY JCST	DATE 04-10-01	CHK JKG	SCALE NONE	SHT 2 OF 2	A

D10100DA/14