

THIS COPY IS PROVIDED ON A RESTRICTED BASIS AND IS NOT TO BE USED IN ANY WAY DETRIMENTAL TO THE INTERESTS OF PANDUIT CORP.

CISCO MDS 9506 SWITCH
(REFERENCE)

DUCTING ASSEMBLY

SIDE BRACKET

INLET DUCT BOX ASSEMBLY

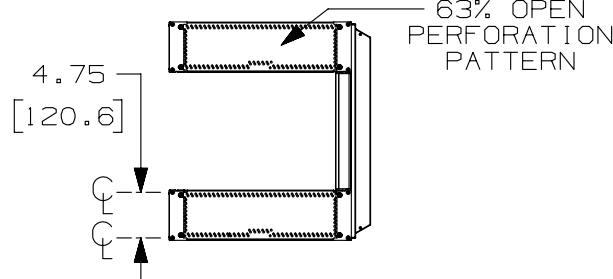
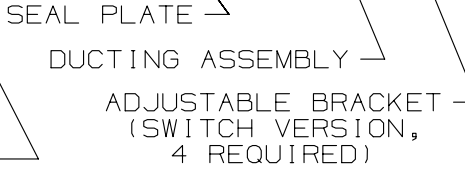
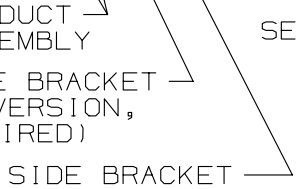
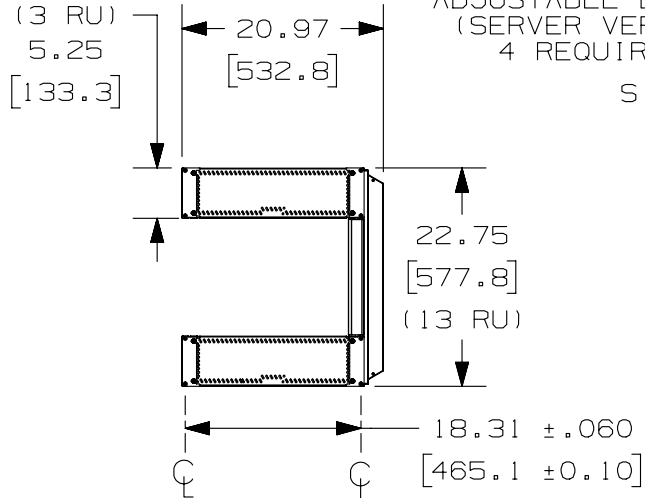
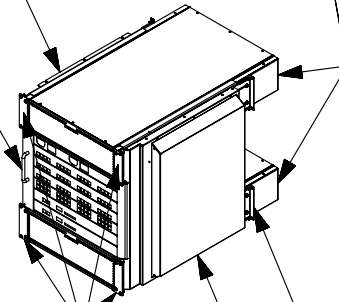
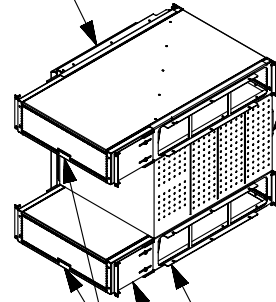
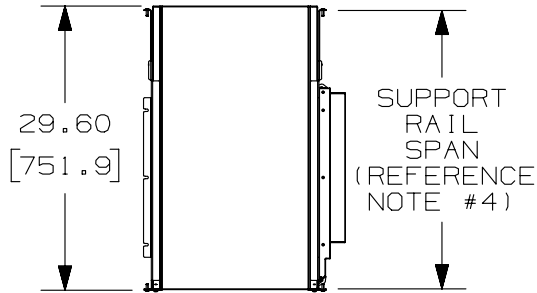

PANDUIT PART NO.	WEIGHT
CNLTD72A3	58.5 LBS/EACH 26.53 kg/EACH

NOTES:

- VISIT OUR ONLINE CATALOG AT WWW.PANDUIT.COM FOR A LIST OF CURRENT PARTS APPLICABLE FOR USE WITH THIS PRODUCT.
- DIMENSIONS IN PARENTHESES ARE METRIC (mm).
- PARTS SUPPLIED:
2 - INLET DUCT BOX ASSEMBLIES
1 - HARDWARE KIT
1 - DUCTING ASSEMBLY
4 - SEAL PLATES
4 - SIDE BRACKETS
4 - ADJUSTABLE BRACKETS (USED W/ SWITCH VERSION)
4 - ADJUSTABLE BRACKETS (USED W/ SERVER VERSION)
- ADJUSTABLE SUPPORT RAIL SPECIFICATIONS:

SWITCH VERSION
RANGE: 24.0-26.0 (609-660)

SERVER VERSION
RANGE: 28-29.25 (711-742)

TITLE	
INLET DUCT FOR CISCO 9506 (CNLTD72A3) CUSTOMER DRAWING	
ITEM REVISION NAME	10V190AV/01
DATASET FILE NAME	10V190AV_DC/01A
MATERIAL:	N/A
DRAWING NUMBER:	10V190AV
DRAWN BY	ERK
DATE	10/27/11
CHK	
SCALE	N/A
SHT 1 OF 4	A

REV	DATE	BY	CHK	APR	DESCRIPTION	ECN
01A	03/06/13	PJST			RELEASED TO PRODUCTION	10V190AV

D10100DA/12

THIS COPY IS PROVIDED ON A RESTRICTED BASIS AND IS NOT TO BE USED IN ANY WAY DETRIMENTAL TO THE INTERESTS OF PANDUIT CORP.

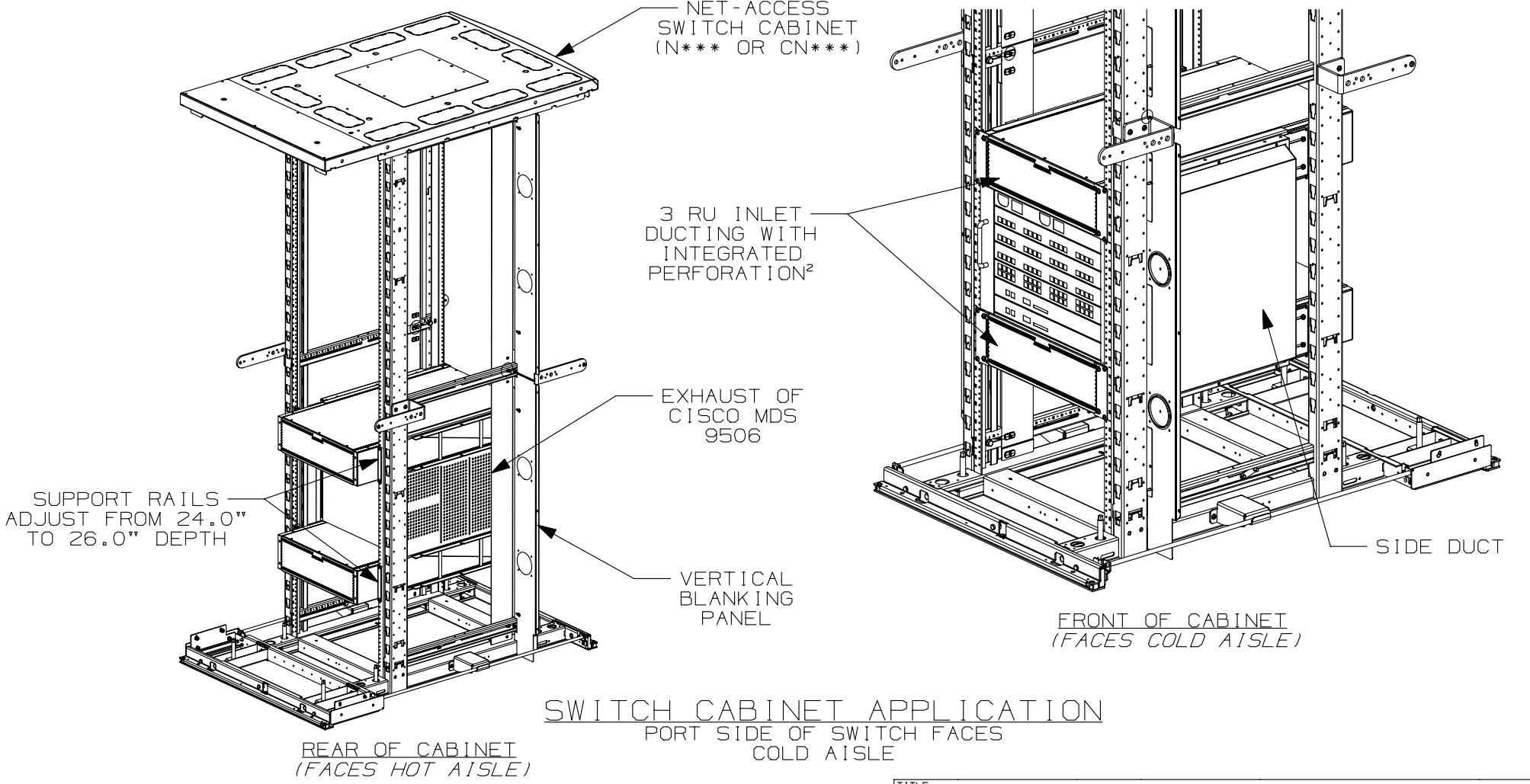

SWITCH CABINET APPLICATION

1. VERTICAL BLANKING PANELS MUST BE USED WITH THIS PRODUCT TO PREVENT EXHAUST RECIRCULATION.

TITLE		INLET DUCT FOR CISCO 9506 (CNLTD72A3)		
		CUSTOMER DRAWING		
ITEM REVISION NAME		10V190AV/01		
DATASET FILE NAME		10V190AV_DC/01A		
		MATERIAL:		
		N/A		
		DRAWING NUMBER:		
		10V190AV		
DRAWN BY	DATE	CHK	SCALE	SIZE
ERK	10/27/11		N/A	A

01A	03/06/13	PJST		RELEASED TO PRODUCTION	10V190AV	
REV	DATE	BY	CHK	APR	DESCRIPTION	ECN

D10100DA/12

THIS COPY IS PROVIDED ON A RESTRICTED BASIS AND IS NOT TO BE USED IN ANY WAY DETRIMENTAL TO THE INTERESTS OF PANDUIT CORP.

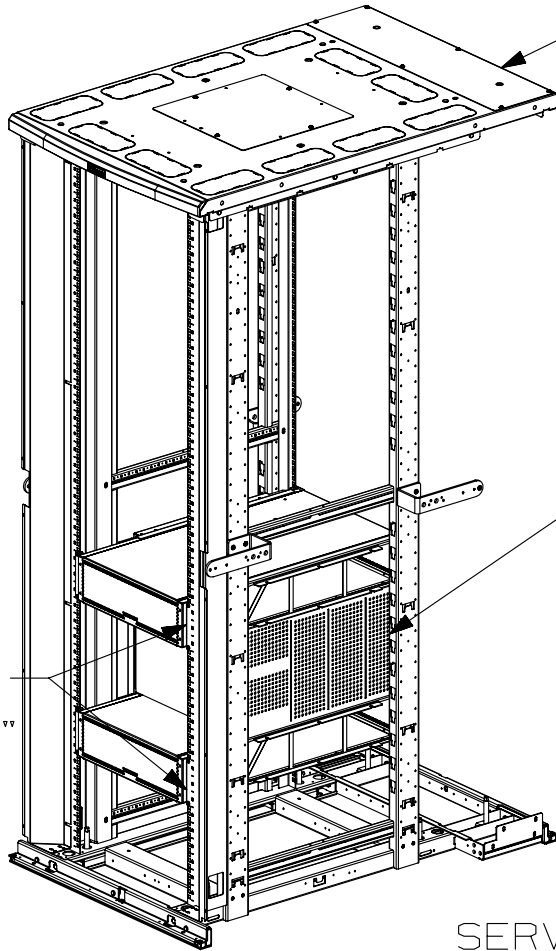

SUPPORT RAILS
ADJUST FROM
28.0" TO 29.25"
DEPTH

FRONT OF CABINET
FACES COLD AISLE

NET-ACCESS
SERVER CABINET
(S*** OR CS***)

3 RU INLET
DUCTING WITH
INTEGRATED
PERFORATION¹

EXHAUST OF
CISCO MDS
9506

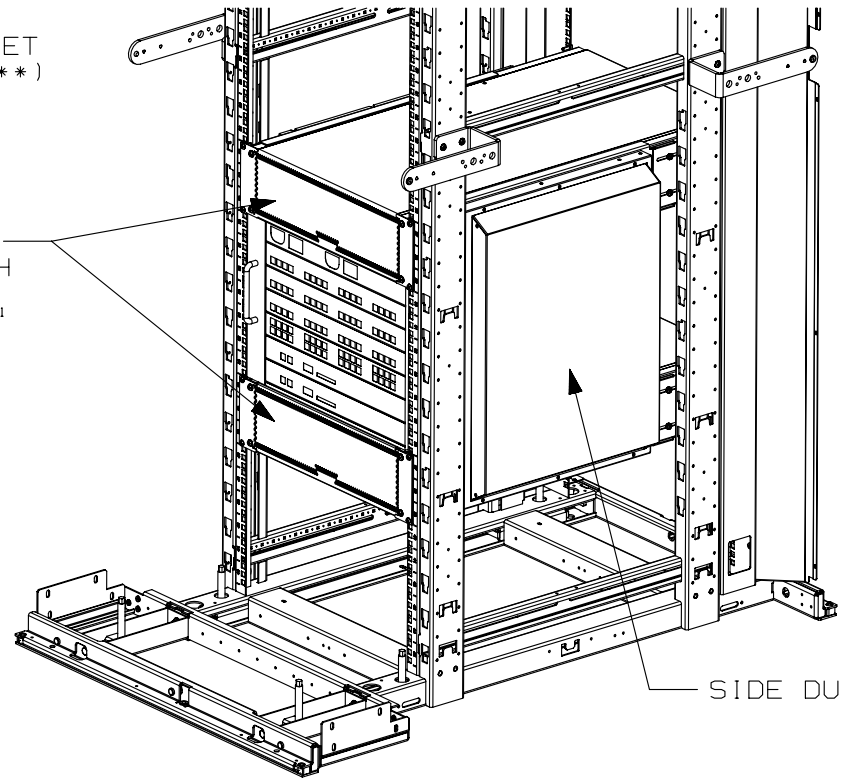

REAR OF CABINET
FACES HOT AISLE

SIDE DUCT

SERVER CABINET APPLICATION
PORT SIDE OF SWITCH FACES
HOT AISLE

TITLE		INLET DUCT FOR CISCO 9506 (CNLTD72A3)		
		CUSTOMER DRAWING		
ITEM REVISION NAME		10V190AV/01		
DATASET FILE NAME		10V190AV_DC/01A		
		MATERIAL: N/A		
		DRAWING NUMBER: 10V190AV		
REV	DATE	BY	CHK	APR
01A	03/06/13	PJST		
DESCRIPTION				ECN
RELEASED TO PRODUCTION				10V190AV
DRAWN BY	DATE	CHK	SCALE	SIZE
ERK	10/27/11		N/A	A
SHT 3 OF 4				

D10100DA/12

THIS COPY IS PROVIDED ON A RESTRICTED BASIS AND IS NOT TO BE USED IN ANY WAY DETRIMENTAL TO THE INTERESTS OF PANDUIT CORP.

45 RU NET-ACCESS
CN*** OR CS***
CABINETS (LEGACY)

42 RU NET-ACCESS
CN*** OR CS***
CABINETS (LEGACY)

DEVICE
KEEP-OUT AREA
RU 41-45

DEVICE
KEEP-OUT AREA
RU 38-42

DEVICE CAN BE
INSTALLED IN
RU'S 27-40

DEVICE CAN BE
INSTALLED IN
RU'S 27-37

DEVICE
KEEP-OUT AREA
RU 20-26

DEVICE
KEEP-OUT AREA
RU 20-26

DEVICE CAN BE
INSTALLED IN
RU'S 6-19

DEVICE CAN BE
INSTALLED IN
RU'S 6-19

DEVICE
KEEP-OUT AREA
RU 1-5

DEVICE
KEEP-OUT AREA
RU 1-5

NOTES:

1. DUE TO PHYSICAL CONSTRAINTS POSED BY FRONT-TO-BACK FRAME BEAMS ON THE LEGACY NET-ACCESS CABINET, THERE ARE CERTAIN AREAS OF THE CABINET THAT THE DEVICE CANNOT BE MOUNTED WHEN USED IN CONJUNCTION WITH THIS INLET DUCT.

2. FOR NET-SERV AND NEW NET-ACCESS (N*** AND S***) CABINETS, THERE ARE NO DEVICE KEEP OUT AREAS. THE ONLY RESTRICTION ON THE SWITCH PLACEMENT IS THAT 3 RU MUST BE LEFT OPEN ABOVE AND BELOW THE SWITCH.

TITLE		INLET DUCT FOR CISCO 9506 (CNLTD72A3)		
		CUSTOMER DRAWING		
ITEM REVISION NAME		10V190AV/01		
DATASET FILE NAME		10V190AV_DC/01A		
		MATERIAL:		
		N/A		
		DRAWING NUMBER:		
		10V190AV		
DRAWN BY	DATE	CHK	SCALE	SIZE
ERK	10/27/11		N/A	A
		SHT 4 OF 4		

01A	03/06/13	ERK			RELEASED TO PRODUCTION	10V190AV
REV	DATE	BY	CHK	APR	DESCRIPTION	ECN

D10100DA/12