

THIS COPY IS PROVIDED ON A RESTRICTED BASIS AND IS NOT TO BE USED IN ANY WAY DETRIMENTAL TO THE INTERESTS OF PANDUIT CORP.

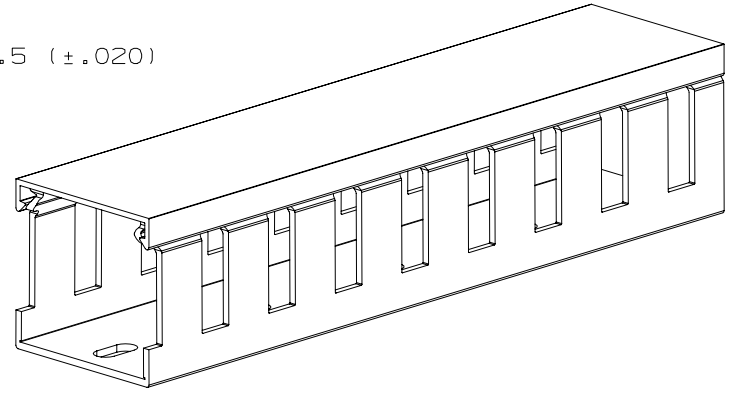
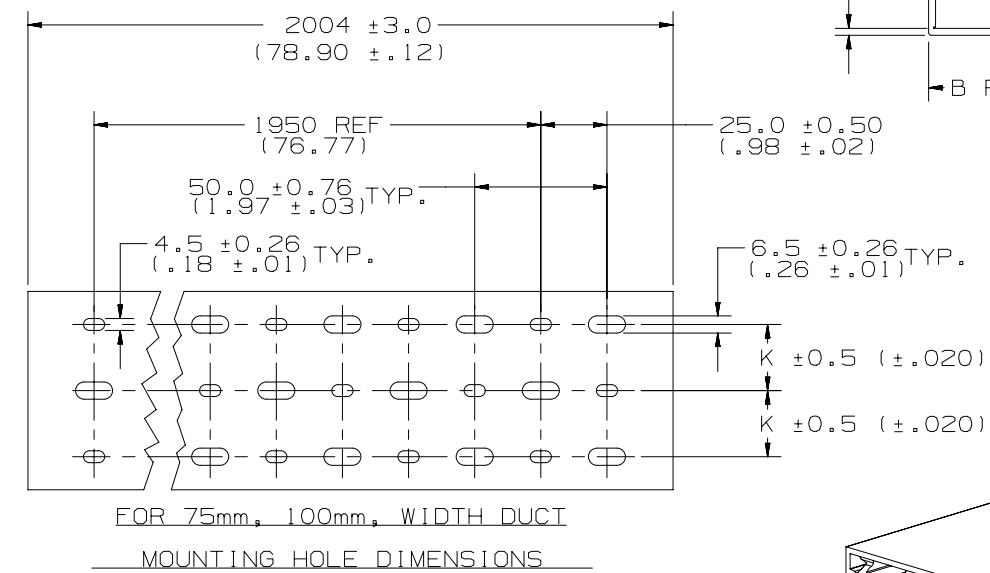
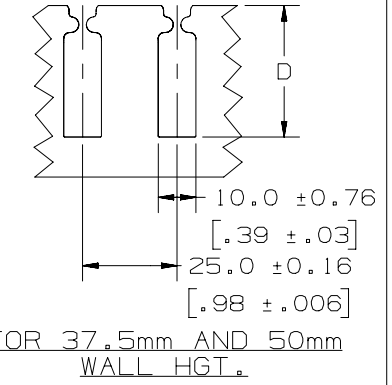
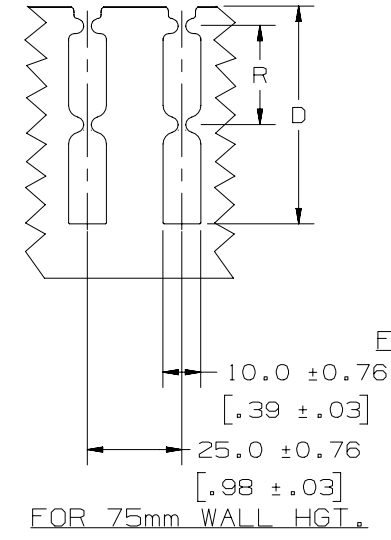
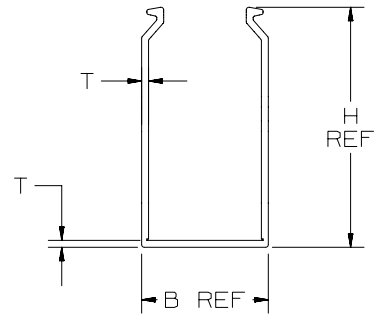
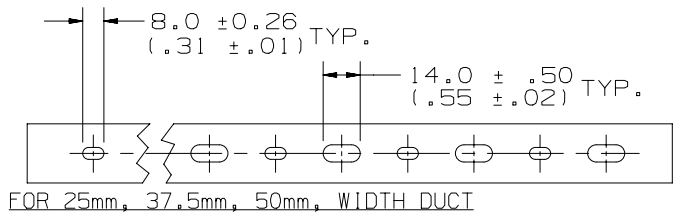

CHANNEL EXAMPLE:  
 NNC 37 X 50 LG 2  
 TYPE — 37mm WIDE — 50mm HIGH — COLOR (LIGHT GRAY) — LENGTH (m)

- NOTES:  
 1. "B" MEASURED AT BASE.  
 2. STANDARD LENGTH: 2.004 METER.  
 3. SEE CURRENT CATALOG FOR PART NUMBER DESIGNATIONS FOR TYPE, COLOR, AND LENGTH.  
 4. DUCT TYPE "NNC" PACKAGED WITH TYPE "NC" COVER.  
 5. DIMENSIONS ARE METRIC (INCHES).

REV	DATE	BY	CHK	APR	DESCRIPTION	ECN
5	09.26.16	BDK	MRJS	RGRO	L. CORRECTED PAST ERRORS "T" DIM	38539-04
4	03-25-13	JBN	RTFI	RTFI	K. UPDATED DRAWING BORDER & TITLE BLOCK	38539-04

TITLE		<b>WIRING DUCT AND COVER TYPE "NNC" METRIC</b>	
ITEM REVISION NAME		CUSTOMER DRAWING	
DATASET FILE NAME		D38539AA/03	
DATASET FILE NAME		D38539AA_DC_NNC/03C	
UNLESS OTHERWISE SPECIFIED, DIMENSIONAL TOLERANCES ARE: mm (IN)		<b>PANDUIT</b> MATERIAL: HALOGEN FREE MODIFIED POLYPHENYLENE OXIDE (PPO)	
.x ± .xx ± 3.1 (0.12) ANGLES ±			
DRAWN BY: JHNU		DRAWING NUMBER: 38539-04	
DATE: 08-02-02		SHT 1 OF 3	
CHK: JKG		SCALE: NONE	
THIRD ANGLE PROJECTION		SIZE: A	

D101000DA/15

THIS COPY IS PROVIDED ON A RESTRICTED BASIS AND IS NOT TO BE USED IN ANY WAY DETRIMENTAL TO THE INTERESTS OF PANDUIT CORP.



PROFILE DIMENSION				
NOMINAL DUCT SIZE (W X H)	B REF	H REF	T	T TOL.
25 X 25	24.6 (.97)	20.5 (.81)	1.4 (.06)	±.26 (.010)
25 X 37	24.6 (.97)	33.0 (1.30)	1.8 (.07)	±.30 (.012)
25 X 50	24.6 (.97)	45.5 (1.79)	2.0 (.08)	±.36 (.014)
25 X 75	24.6 (.97)	70.5 (2.78)	2.0 (.08)	±.36 (.014)
37 X 37	37.1 (1.46)	33.0 (1.30)	1.8 (.07)	±.30 (.012)
37 X 50	37.1 (1.46)	45.5 (1.79)	2.0 (.08)	±.36 (.014)
37 X 75	37.1 (1.46)	70.5 (2.78)	2.0 (.08)	±.36 (.014)
50 X 50	49.6 (1.95)	45.5 (1.79)	2.0 (.08)	±.36 (.014)
50 X 75	49.6 (1.95)	70.5 (2.78)	2.0 (.08)	±.36 (.014)
50 X 100	49.6 (1.95)	95.5 (3.76)	2.3 (.09)	±.50 (.020)
75 X 75	74.6 (2.94)	70.5 (2.78)	2.0 (.08)	±.36 (.014)
100 X 50	99.6 (3.92)	45.5 (1.79)	2.0 (.08)	±.36 (.014)
100 X 75	98.6 (3.92)	70.5 (2.78)	2.0 (.08)	±.50 (.020)
100 X 100	99.6 (3.92)	95.5 (3.76)	2.3 (.09)	±.50 (.020)

MOUNTING HOLE	
NOMINAL DUCT WIDTH	K ±.5 (.02)
25	----
37	----
50	----
75	25.0 (.98)
100	25.0 (.98)

SLOT DIMENSION		
NOMINAL DUCT HEIGHT	D ±.8 (.03)	R ±.75 (.02)
25	13.6 (.54)	-----
37	24.7 (.97)	-----
50	34.8 (1.37)	-----
75	57.6 (2.27)	26.26 (1.03)
100	81.0 (3.19)	38.0 (1.50)

ALL DIMENSIONS ARE METRIC (INCHES)

REV	DATE	BY	CHK	APR	DESCRIPTION	ECN
5	09.26.16	BDK	MRJS	RGR0	SEE SHEET 1 OF 3 FOR REVISIONS DESCRIPTION	38539-04
4	03-25-13	JBN	RTFI	RTFI	SEE SHEET 1 OF 3 FOR REVISIONS DESCRIPTION	38539-04

TITLE		<b>WIRING DUCT AND COVER TYPE "NNC" METRIC</b>	
		CUSTOMER DRAWING	
ITEM REVISION NAME		D38539AA/03	
DATASET FILE NAME		D38539AA_DC_NNC/03C	
UNLESS OTHERWISE SPECIFIED, DIMENSIONAL TOLERANCES ARE: mm (IN)		<b>PANDUIT</b>	
.x ± .xx ± 3.1 (0.12) ANGLES ±			
DRAWN BY		MATERIAL:	
JHNU		HALOGEN FREE MODIFIED POLYPHENYLENE OXIDE (PPO)	
DATE		DRAWING NUMBER:	
08-02-02		38539-04	
CHK		THIRD ANGLE PROJECTION	
JKG			
SCALE		SHT 2 OF 3	
NONE		A	

D10100DA/15

THIS COPY IS PROVIDED ON A RESTRICTED BASIS AND IS NOT TO BE USED IN ANY WAY DETRIMENTAL TO THE INTERESTS OF PANDUIT CORP.

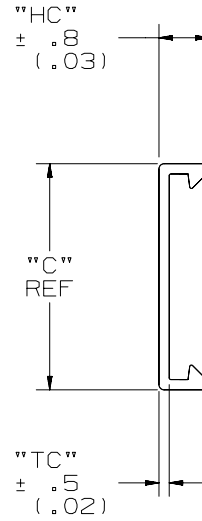
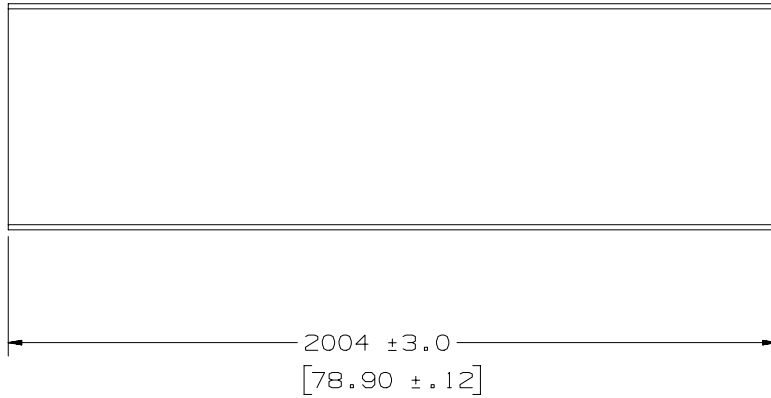

NOMINAL DUCT SIZE (W)	C REF	HC	TC
25	24.6 (.97)	8.9 (.35)	1.30 (.05)
37	37.1 (1.46)	8.9 (.35)	1.30 (.05)
50	49.6 (1.95)	8.9 (.35)	1.40 (.06)
75	74.6 (2.94)	9.4 (.37)	1.40 (.06)
100	99.6 (3.92)	9.4 (.37)	1.40 (.06)

ALL DIMENSIONS ARE METRIC (INCHES)

REV	DATE	BY	CHK	APR	DESCRIPTION	ECN
5	09.26.16	BDK	MRJS	RGRO	SEE SHEET 1 OF 3 FOR REVISIONS DESCRIPTION	38539-04
4	03-25-13	JBN	RTFI	RTFI	SEE SHEET 1 OF 3 FOR REVISIONS DESCRIPTION	38539-04

TITLE <b>WIRING DUCT AND COVER TYPE "NNC" METRIC</b> CUSTOMER DRAWING					
ITEM REVISION NAME D38539AA/03			<b>PANDUIT</b>		
DATASET FILE NAME D38539AA_DC_NNC/03C					
UNLESS OTHERWISE SPECIFIED, DIMENSIONAL TOLERANCES ARE: mm [IN] .x ± 2.54 [0.1] .xxx ± .127 [.005] .xx ± .25 [.01] ANGLES ± 1°			MATERIAL: HALOGEN FREE MODIFIED POLYPHENYLENE OXIDE (PPO)		
DRAWN BY JHNU			DATE 08-02-02		DRAWING NUMBER: 38539-04
CHK JKG			SCALE NONE		SIZE A
SHT 3 OF 3					

D10100DA/15