







THIS COPY IS PROVIDED ON A RESTRICTED BASIS AND IS NOT TO BE USED IN ANY WAY DETRIMENTAL TO THE INTERESTS OF PANDUIT CORP.

PART NO.	BACKGROUND COLOR	LEGEND COLOR	DETAIL "A"
PEIP-A-18Y	PURPLE	WHITE	
PEIP-A-19Y	GREEN	WHITE	
PEIP-A-20Y	BLUE	WHITE	
PEIP-A-21Y	RED	WHITE	
PEIP-A-22Y	ORANGE	WHITE	

- NOTES:
 1. MILLIMETERS ARE IN [].
 2. 10 MARKER PER CARD.
 3. 10 CARDS PER PACKAGE.

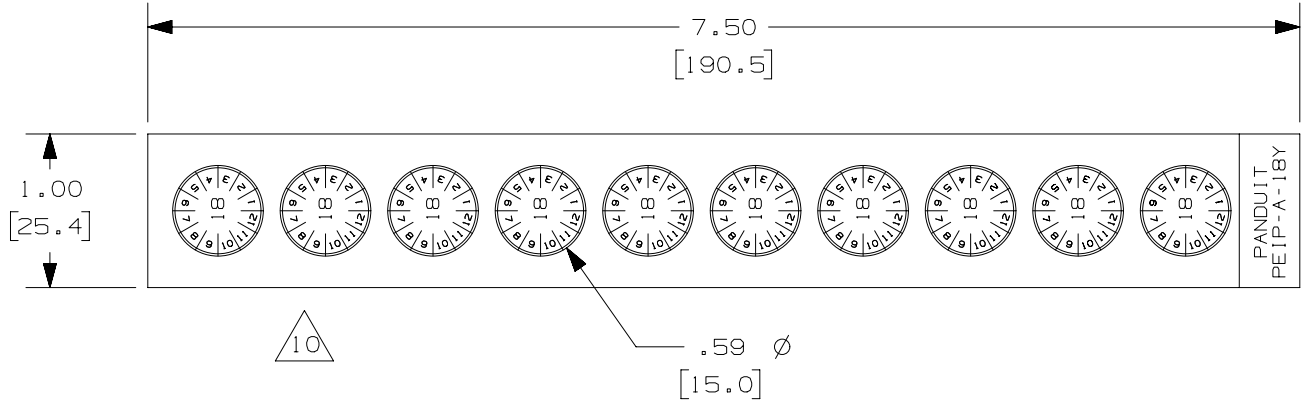

10	7/10/18	RVU	DJW	JHAC	REMOVED PEIP-A-17Y, ADD PEIP-A-22Y.	GAECN04624
9	1/4/17	RVU	DJW	JHAC	REMOVED PEIP-A-16Y, ADD PEIP-A-21Y.	GAECN03932
8	1/7/16	SMY	SEWH	JHAC	REMOVED PEIP-A-15Y, ADD PEIP-A-20Y.	GAECN03313
7	1/12/15	RVU	MJPF	MSAD	REMOVED PEIP-A-14Y. ADD PEIP-A-19Y.	GAECN02514
6	2/7/13	RVU	MJPF	MSAD	REMOVED PEIP-A-13Y. ADD PEIP-A-18Y.	GAECN01532
5	5/24/13	RVU	MJPF	MSAD	GMV10-0L WAS GMV10 VINYL.	GAECN00662
4	2/7/13	RVU	MJPF	MSAD	REMOVED PEIP-A-12Y. ADD PEIP-A-17Y.	GAECN00593

TITLE					
PEIP WRITE-ON MARKER LABEL					
CUSTOMER DRAWING					
ITEM REVISION NAME			100318HM/19		
DATASET FILE NAME			100318HM_DC_C10721/19N		
UNLESS OTHERWISE SPECIFIED, DIMENSIONAL TOLERANCES ARE: IN [mm]			 GMV10-0L		
.x ± .12 [3.05] .xxx ± .025 [.635] .xx ± .062 [1.57] ANGLES ±					
DRAWN BY			DATE	CHK	SCALE
RVU			7/28/08	MSAD	NTS
DRAWING NUMBER:					SIZE
C10721					A
REV				DATE	DESCRIPTION
RVU				7/28/08	DESCRIPTION
ECN				SHT 1 OF 1	

D10100DA/12