

### Understanding the Label

**IMPORTANT!** Determine the desired direction of cable **before** wiring the cap. The cap, in relation to the jack, **must** be kept consistent throughout the entire termination.

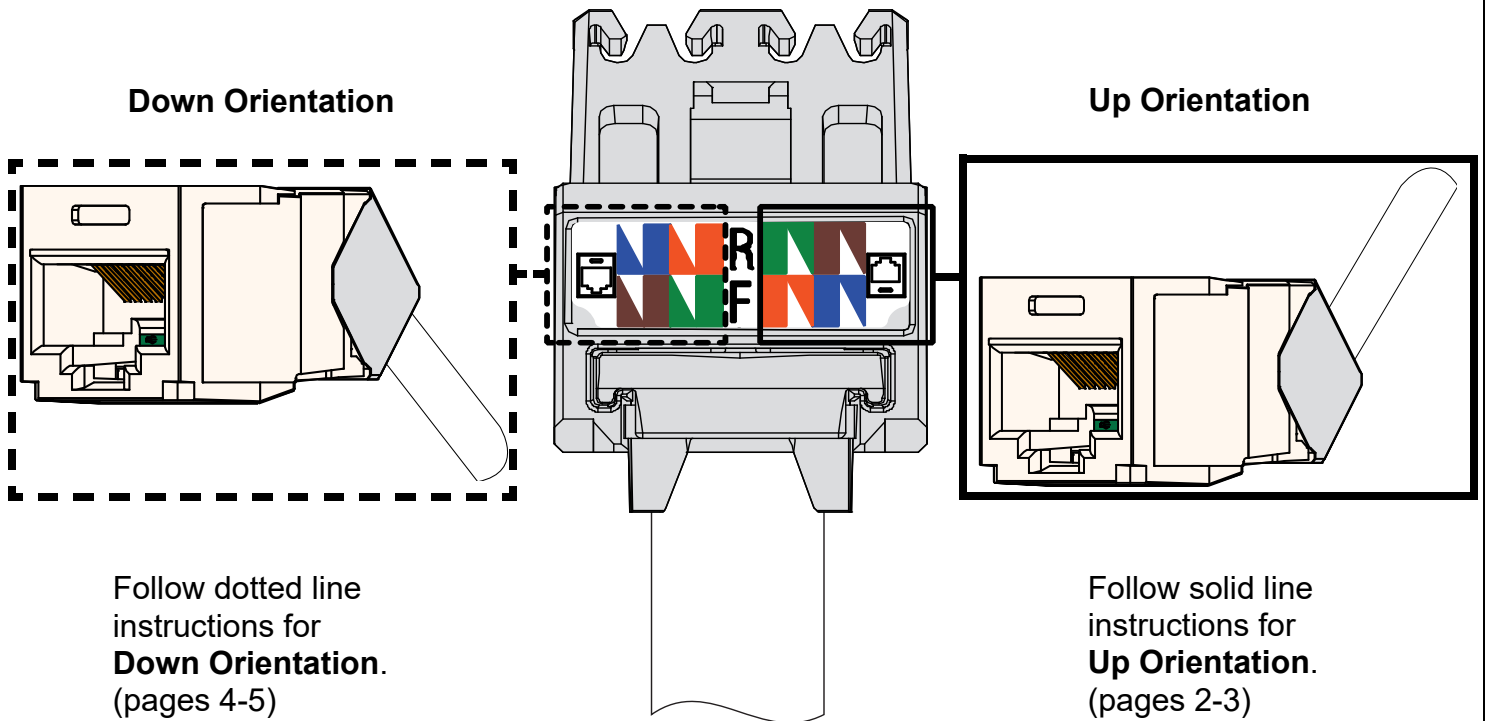

### Up Orientation

1

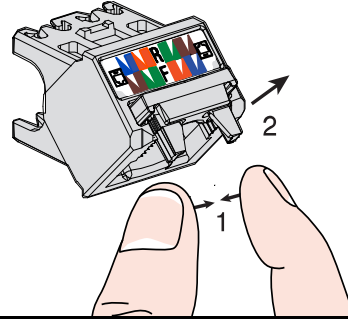
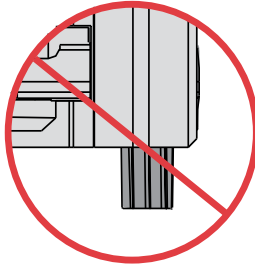
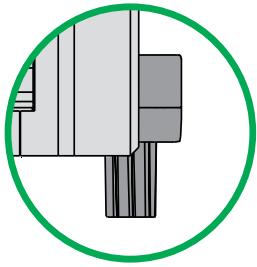

**IMPORTANT!:**  
Be sure that strain relief is fully retracted before inserting cable.

2

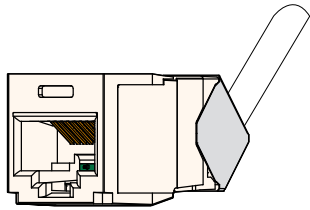
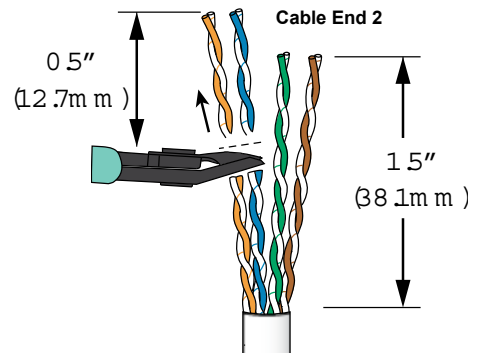
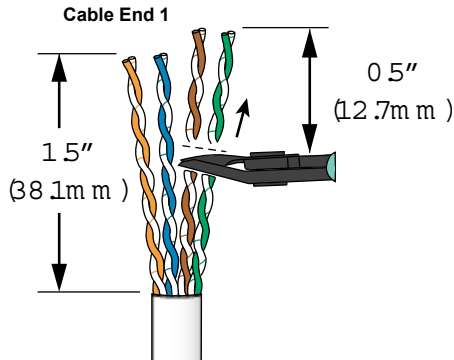

3



Do not pre-arrange conductors.

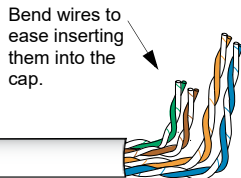

Bend wires to ease inserting them into the cap.

4

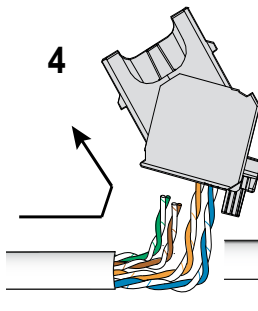

5

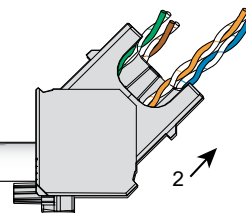

Cable End 1 Shown

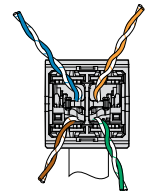

Cable End (1)

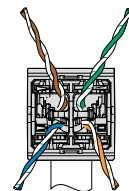

Cable End (2)

6

Be sure cable is fully inserted into wire cap

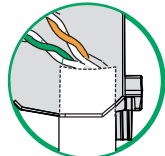
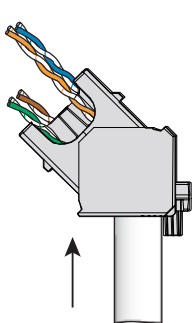

TGSJT

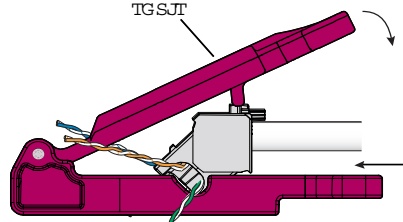

Cable End 1 Shown

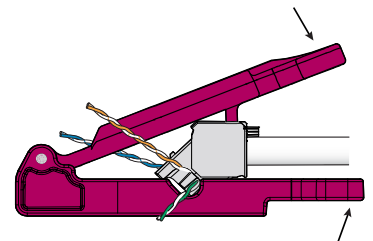

### Up Orientation

#### 7 T568B Wiring

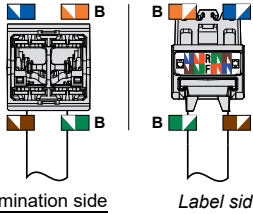

Cable End 1

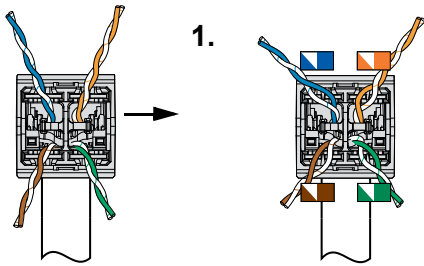

Cable End 2

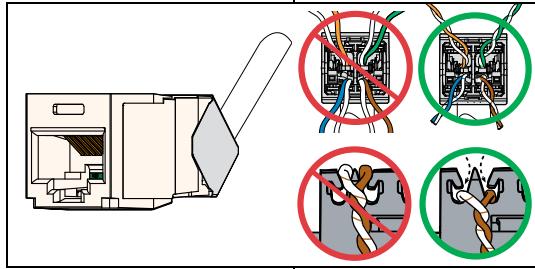
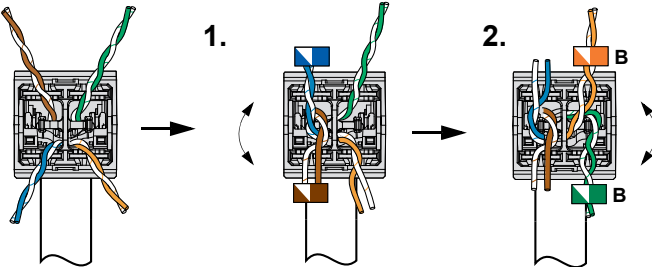

#### T568A Wiring

T568A not shown on wire map label

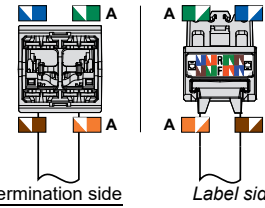

Cable End 1

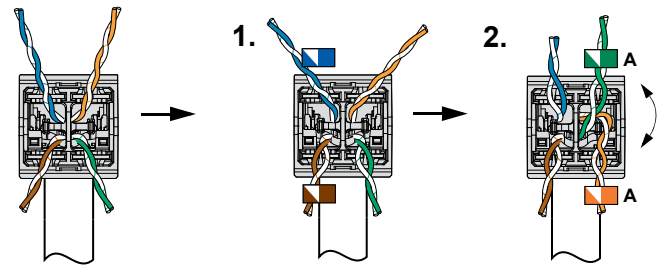

Cable End 2

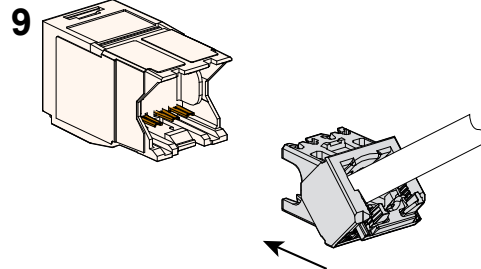
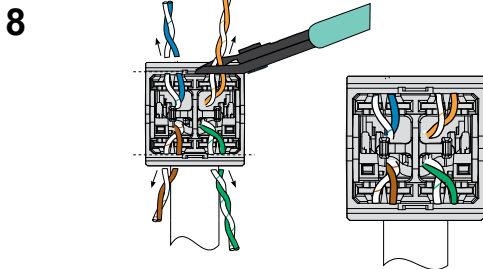
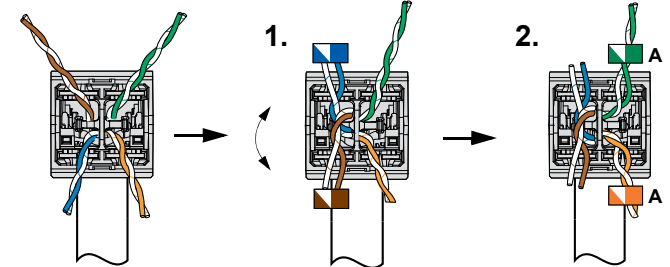

**Important!**  
Maintain orientation of cap in relation to jack from previous steps.

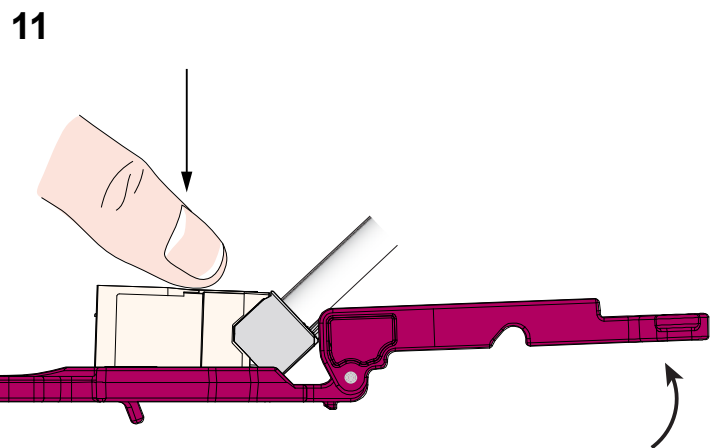
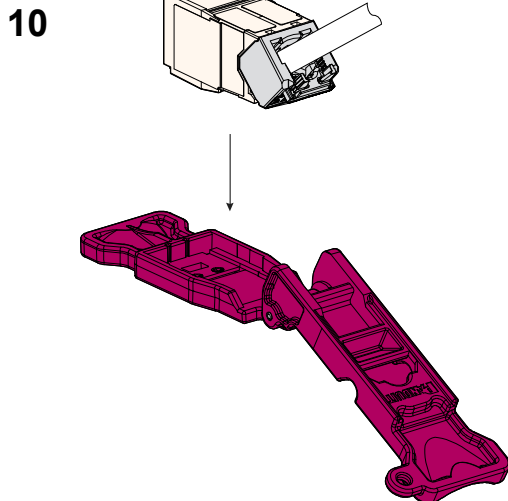

### Down Orientation

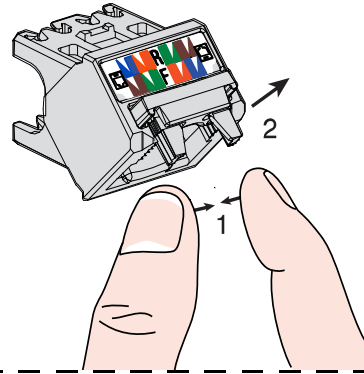
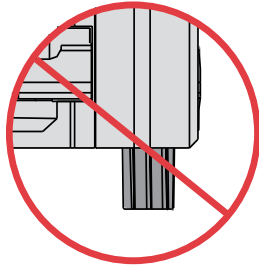
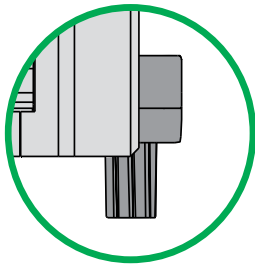

**IMPORTANT!:**  
Be sure that strain relief is fully retracted before inserting cable.

2

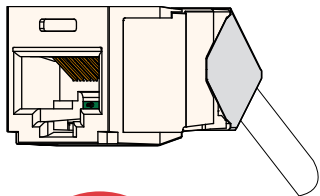
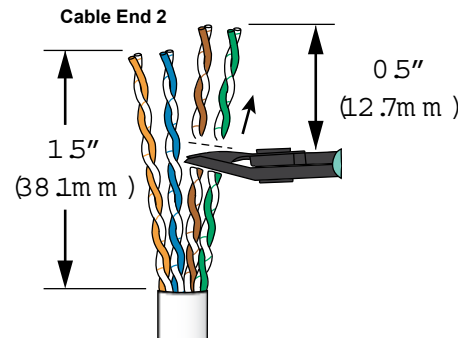
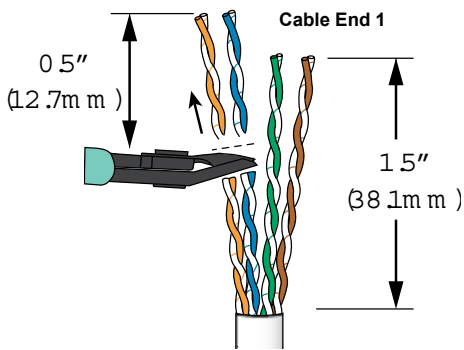

3

Bend wires to ease inserting them into the cap.

4

5

Do not pre-arrange conductors.

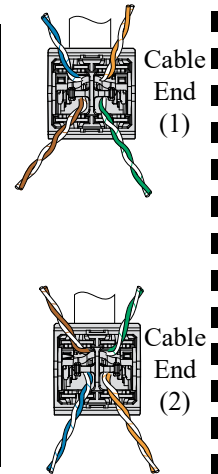
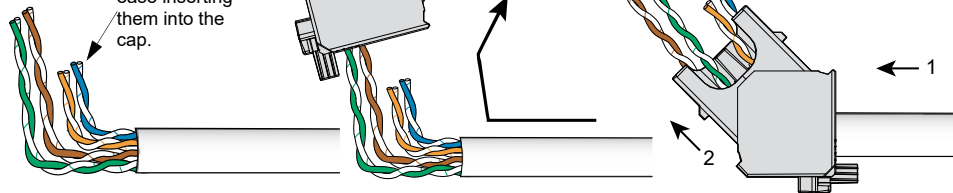

Cable End 1 Shown

6

Be sure cable is fully inserted into wire cap

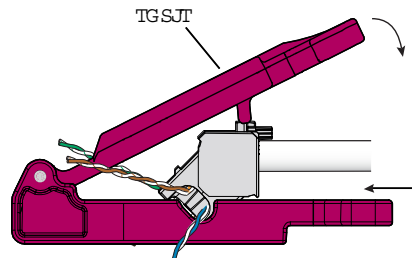
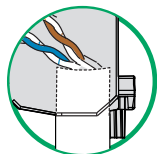
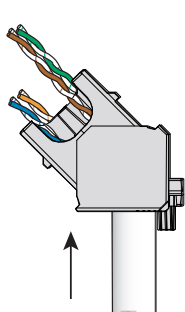

Cable End 1 Shown

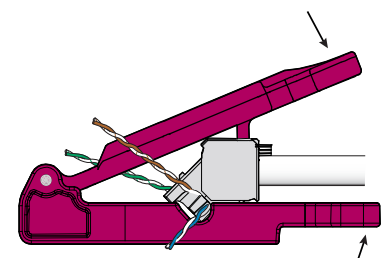

Down Orientation

7

T568B Wiring

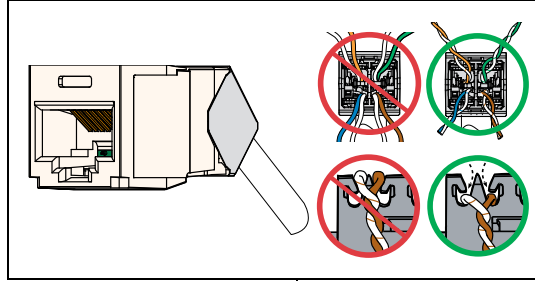
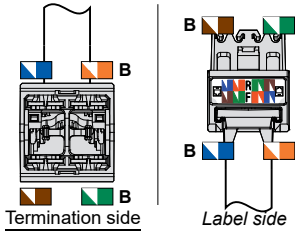

T568A Wiring

T568A not shown on wire map label

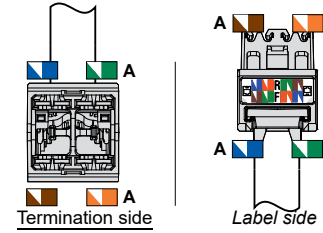

Cable End 1

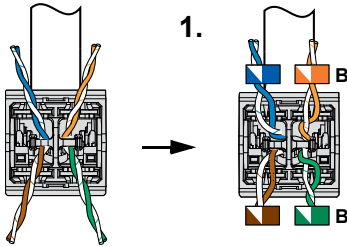

Cable End 1

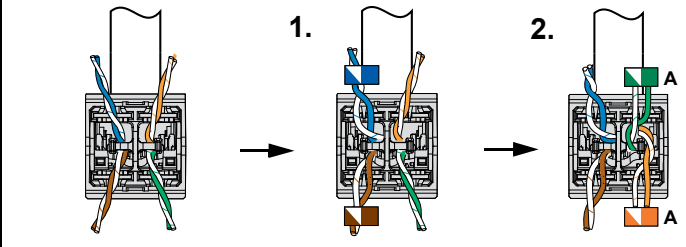

Cable End 2

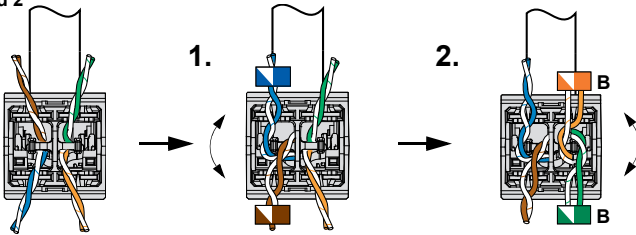

Cable End 2

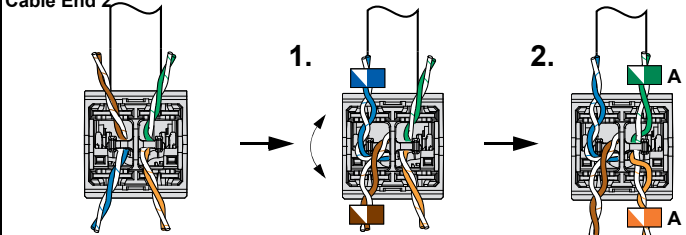

8

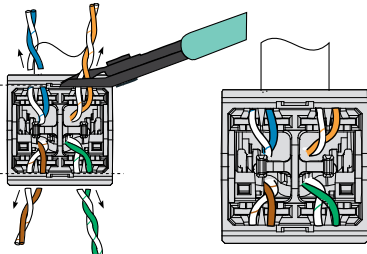

9

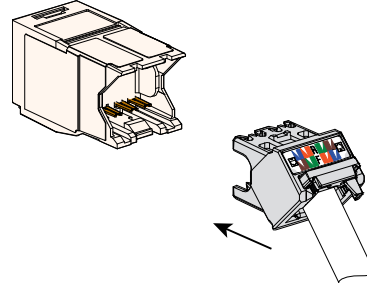

**Important!**  
Maintain orientation of cap in relation to jack from previous steps.

10

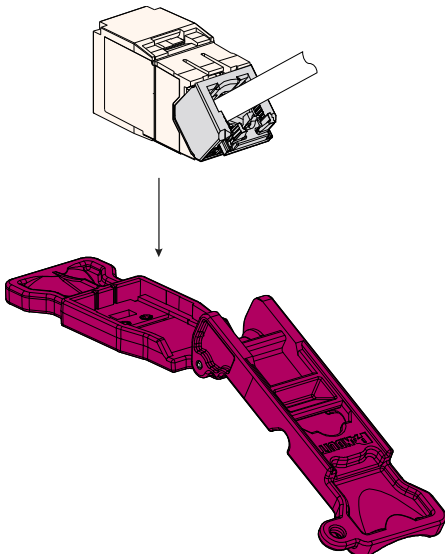

11

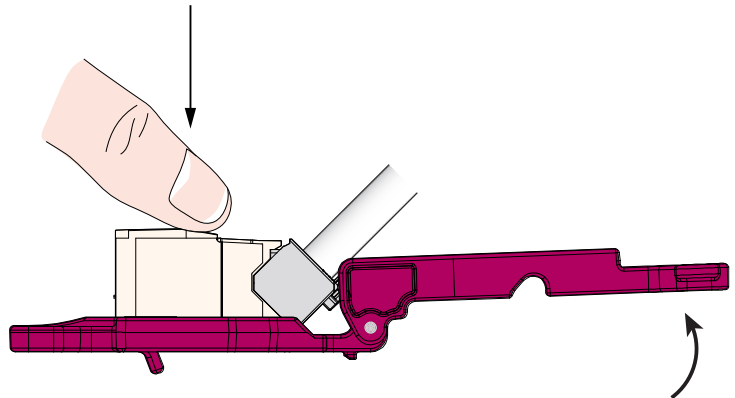

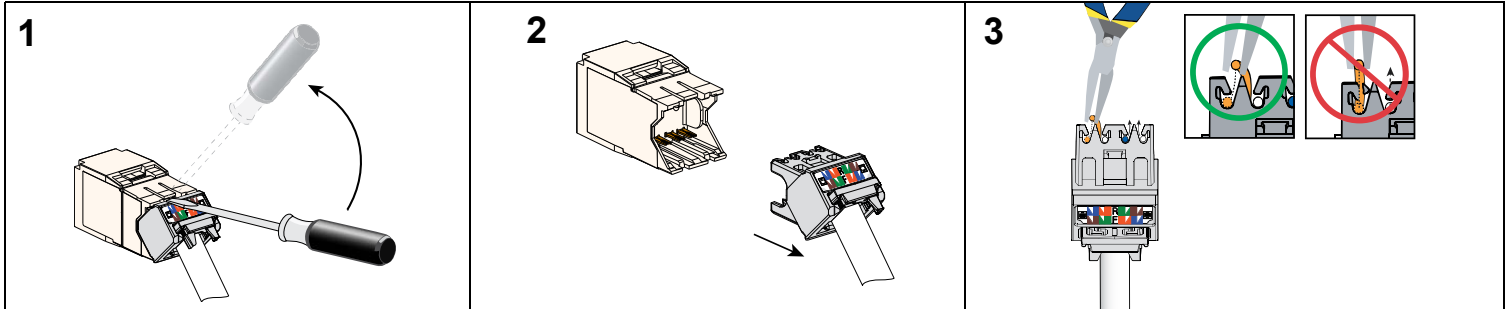
**REMOVAL STEPS****Notes:**

1. For specified performance, follow TIA/EIA 568-C installation guidelines.
2. Jack Modules can terminate 22-26 AWG solid data cable with 0.062" (1.57mm) maximum insulated conductor outside diameter.
3. Jack Modules may be re-terminated at least 20 times.
4. For technical and performance information, consult Panduit Technical Support.

**As with all Wiring Accessories, the following statements apply:**

1. Never install communications wiring during a lightning storm.
2. Never install communications wiring in wet locations unless the jack is specifically designed for use in wet locations.
3. Never touch uninsulated communications wiring or terminals unless the communication line has been disconnected at the network interface.
4. Use caution when installing or modifying communication wiring.