



BlackFin
CT-2940/STBT
Instruction Manual



Serialnumber



CT-2940/STBT



WARNING

Read all safety warnings, instructions, illustrations and specifications provided with this power tool.

Failure to follow all instructions listed below may result in electric shock, fire and/or serious injury.

Save all warnings and instructions for future reference.

datecode

Year	Code	Month	Code	Month	Code
2022	R	Jan.	N	July	V
2023	S	Feb.	P	Aug.	W
2024	T	Mar.	Q	Sept.	X
2025	V	Apr.	R	Oct.	Y
2026	W	May	S	Nov.	Z
2027	X	June	T	Dec.	1

batch# e.g. 304711
 datecode e.g. X = 2027; N = Jan.
 consecutive# e.g. „142“ = tool # 142

FCC ID: RFRMS42 • IC: 4957A-MS42
 Model: CFM

This device complies with Part 15 of the FCC Rules and with Industry Canada licence-exempt RSS standard(s). Operation is subject to the following two conditions: (1) this device may not cause harmful interference, and (2) this device must accept any interference received, including interference that may cause undesired operation.

HE.18055_D

304711
 XN
 142

Klauke
 Auf dem Knapp 46
 D-42855
 Remscheid

2 years Warranty
 Bei Beschädigung Garantieverlust
ATTENTION! Warranty seal if broken loses of Warranty

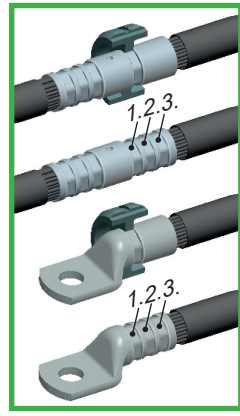



CT-2940/STBT

PANDUIT
infrastructure for a connected world

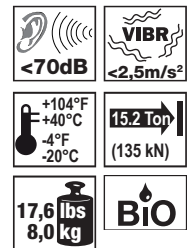
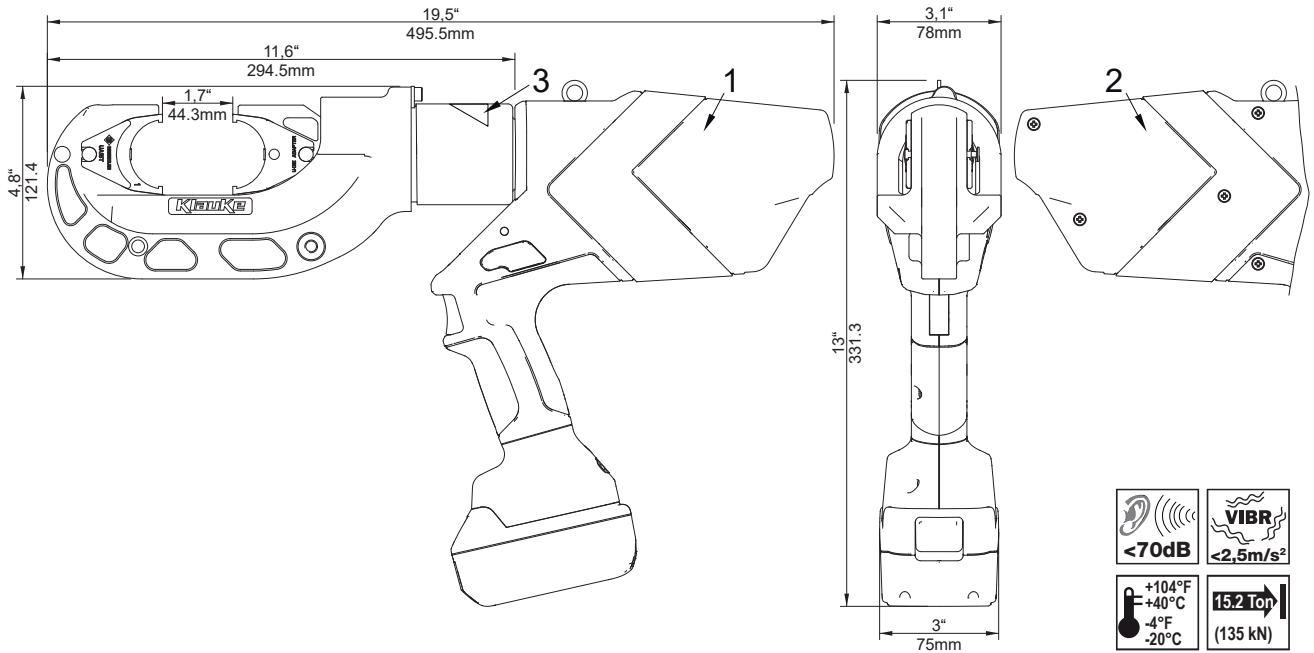

1

PANDUIT



HE 20206

2

PANDUIT

CT-2940/STBT Crimping Tool
Voltage: 18 V ~ • Force: 15.2 Ton (135kN)
Gustav Klauke GmbH • Auf dem Krapp 46
42855 Remscheid Germany • EK13SCFMPAN
For use only with 18 V Makita battery

LISTED TOOL
80103907

HE 20206

3



Use tool only with 18 V Makita battery

Makita BL1840 18V ~ 4.0Ah 72Wh	Makita Li-ion BL1830 18V ~ 3.0Ah 54Wh	Makita Li-ion BL1815 18V ~ 24Wh
Makita BL1850 18V ~ 5.0Ah 90Wh		

BL1850(B) RAL4	45 min.
BL1840(B) RAL4	36 min.
BL1830(B) RAL2	22 min.
BL1815 RAL1	15 min.

10 - 40°C

Makita DC18RC T
Prim.: 220V-240V ~ 240W 50-60Hz
Sek.: 7.2V-18V ~ 9A
0505611
T4A
CH.P/N: 630718-5
Makita Corporation

Alle Bedienungsanleitungen auch unter www.klauke.de abrufbar
All manuals are also available on www.Klauke.com



CT-2940/STBT

BEFORE WORK

DIN EN 50110

2 years Warranty
World wide Tool Service
KLAUKE ASC
Authorized Service Center

- 1.
- 2.
- 3.

once a year

Authorised Service Center

Recommendation
Empfehlung

3 years or 10.000 operations

Authorised Service Center

2 years Warranty
World wide Tool Service
KLAUKE ASC
Authorized Service Center

WEEE 2012/19/EU

klauke-weee-abholung@emerson.com

Authorised Service Center

LED on/off

LED

on/off

PRESS

!

MAN

PRESS

QUICK STOP

QUICK STOP



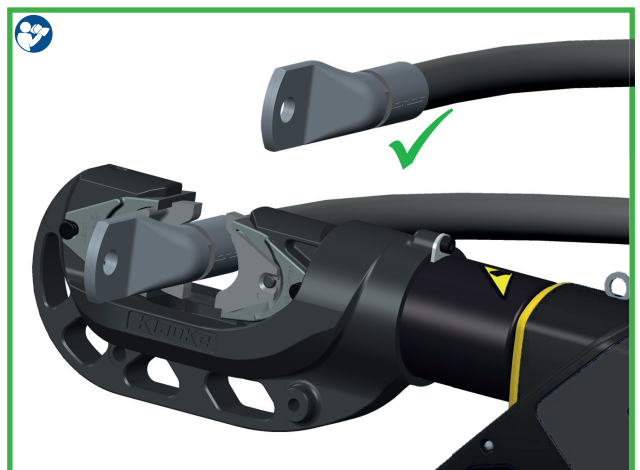
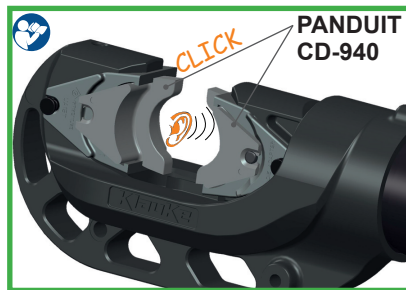
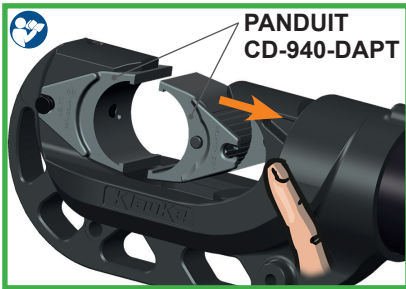

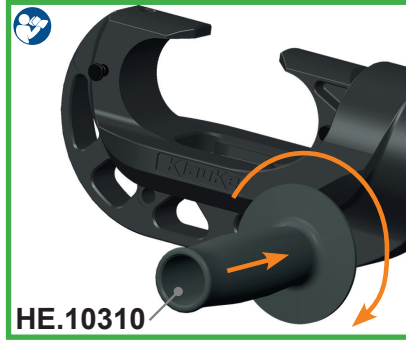

WARNING

Hydraulic tools can be heavy and might require additional support.
Never overestimate your ability to handle the tool.

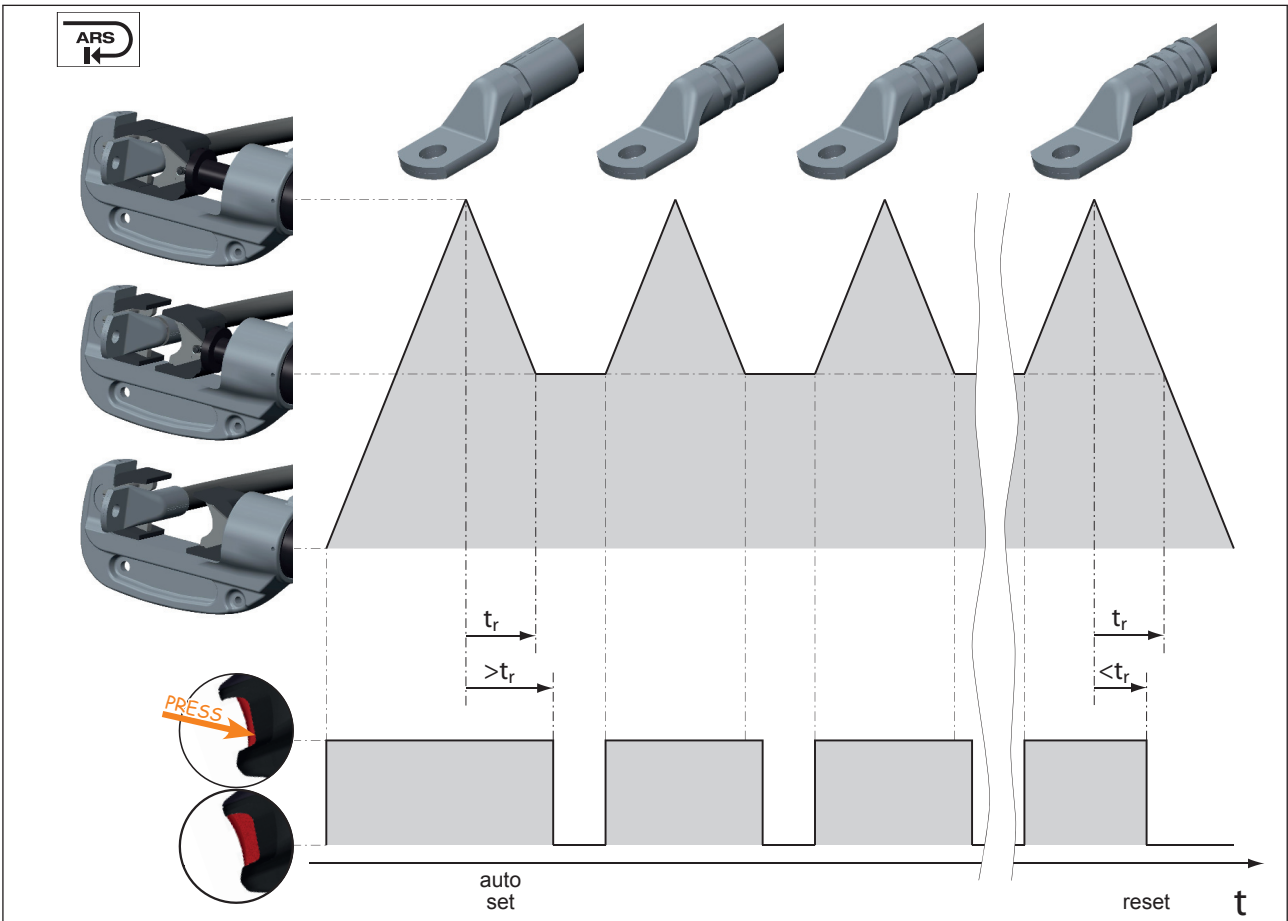



1			
2		PANDUIT	
		ERROR CODE: ****	Error code *1
3a		BT P 3 bar P 3 bar	Bluetooth (if connected) Battery charging level Current pressure Pressure max. *2
3b	 3 sec.	bar / psi	to change: bar / psi
3c		bar / psi	
3b	 3 sec.	kN / lbf	to change: kN / lbf
3d		BT F 74 lbf F 369 lbf	
4a		USER 3: RD3 Doppelklick	Doubleclick
4b	 3 sec.	USER SELECT: RD3 Einfachklick	Singleclick enter menu
4c		USER SELECT: RD3 Doppelklick	Doubleclick select
4d		USER SELECT: RD3 Doppelklick	Doubleclick confirmed
5		NEXT SERVICE: 9826 0Ps	Cycles (until next service)
6		TOTAL: t = 0.07 h Q = 21.12 Ah n = 174	Since manufacturing: operating hours Capacity # crimps
7		RETURN	

*1 Error codes:

- Overcurrent fuse
- Overcurrent comparator
- Overheat board
- Overheat battery
- Battery empty, operation stop
- Faulty crimp motor in operation
- Faulty crimp motor not in operation
- Low battery
- Battery empty
- RTC battery low
- Service necessary
- RTC not found
- BT unit not found
- Pressure sensor not found
- Burst pressure exceeded
- Battery temperature too low

1 Überstrom durch Überstromsicherung
2 Überstrom durch Komparator
3 Boardtemperatur zu hoch
4 Akkutemperatur zu hoch
5 Akkuspannung während der Operation zu gering
6 Fehlpressung bei laufendem Motor
7 Fehlpressung bei stehendem Motor
8 Niedrige Akkuspannung
9 Akku leer
10 RTC-Batterie leer
11 Werkzeug deaktiviert
12 Service nötig
13 RTC nicht verfügbar
14 BT-Modul nicht verfügbar
16 Drucksensor nicht verfügbar
17 Berstdruck überschritten
18 Akkutemperatur zu gering

*2 (2Hz)

Klaue i-press® Software
www.klaue.com/connectivity

Klaue i-press® App

Download on the App Store

ANDROID APP ON Google play

	 ≤ 20 sec.					
	 > 20 sec.		 ≤ 20 sec.			

REPEAT

For US and Canada only













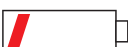

Le présent appareil est conforme aux CNR d'Industrie Canada applicables aux appareils radio exempts de licence. L'exploitation est autorisée aux deux conditions suivantes:

- l'appareil ne doit pas produire de brouillage, et
- l'utilisateur de l'appareil doit accepter tout brouillage radioélectrique subi, même si le brouillage est susceptible d'en compromettre le fonctionnement.

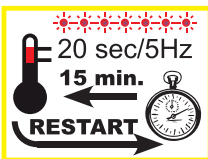
NOTICE:

Changes or modifications made to this equipment not expressly approved by Klaue may void the FCC authorization to operate this equipment.



			<p>Wann/When/Quand/Quando/ cuándo/Wanneer/Когда/это происходит/Kiedy/quando</p>	<p>Warum/Why/Pourquoi/Porquê/ ¿por qué?/Waarom/Причина/ Dlaczego/Perché</p>
 20 sec			<p>nach Arbeitsvorgang after working cycle après opération de travail Después del proceso de trabajo após o processo de trabalho na bedrijfscyclus после цикла опрессовки po zakończeniu pracy dopo il processo di lavoro</p>	
 20 sec/2Hz			<p>nach Arbeitsvorgang after working cycle après opération de travail Después del proceso de trabajo após o processo de trabalho na bedrijfscyclus после цикла опрессовки po zakończeniu pracy dopo il processo di lavoro</p>	 Authorised Service Center
 20 sec/5Hz			<p>während der Übertemperatur while exceeding the temp. limit pendant surchauffe en caso de temperatura excesiva durante a temperatura excessiva tijdens te hoge temperatuur при высокой температуре внутри корпуса przy przegrzaniu superando il limite di temperatura</p>	<p>Werkzeug zu heiß Unit too hot outil surchauffé Herramienta demasiado caliente ferramenta demasiado quente gereedschap te heet Перегрев инструмента urządzenie za gorące Utensile troppo caldo</p> 
 1 x	 1 x		<p>nach Arbeitsvorgang after working cycle après opération de travail Después del proceso de trabajo após o processo de trabalho na bedrijfscyclus после цикла опрессовки po zakończeniu pracy dopo il processo di lavoro</p>	<p>Fehler: der notwendige Pressdruck wurde nicht erreicht. Es handelt sich um eine manuelle Unterbrechung der Pressung bei stehendem Motor. Error: the required pressure has not been reached. The operator has interrupted the pressing cycle manually while the motor was not running. ERREUR: Pression nécessaire pas atteinte. Il s'agit d'une interruption manuelle de la sertissage au moteur arrêté. Error: No se ha alcanzado la presión necesaria o el operador ha interrumpido el ciclo a mano mientras el motor ha parado. Falha: a pressão de prensagem necessária não foi alcançada. Trata-se de uma interrupção manual da prensagem com o motor parado. Foutmelding: De benodigde persdruk wordt niet bereikt. De gebruiker heeft de verkramping handmatig stopgezet aangezien de motor niet actief is. Ошибка: не было достигнуто требуемое усилие опрессовки или оператор прервал процесс опрессовки вручную, когда двигатель остановился. Błąd: konieczne ciśnienie nie zostało osiągnięte. Użytkownik przerwał cykl pracy ręcznie w chwili, gdy silnik nie był włączony Errore: la pressione richiesta non è stata raggiunta. L'operatore ha interrotto manualmente il ciclo di pressatura mentre il motore non è in funzione.</p>
 3 x	 3 x		<p>nach Arbeitsvorgang after working cycle après opération de travail Después del proceso de trabajo após o processo de trabalho na bedrijfscyclus после цикла опрессовки po zakończeniu pracy dopo il processo di lavoro</p>	<p>Schwerwiegender Fehler: Pressdruck wurde bei laufendem Motor nicht erreicht. Serious Error: The pressure has not been reached while the motor was running. Erreur Grave: Pression pas atteinte au moteur courant. Error grave: No se ha alcanzado presión mientras el motor estaba en marcha Falha grave: a pressão de prensagem não foi alcançada com o motor em funcionamento. Urgente foutmelding: De persdruk werd bij een werkende motor niet bereikt. Серьезная ошибка: не было достигнуто требуемое усилие опрессовки во время работы двигателя Poważny błąd: konieczne ciśnienie nie zostało osiągnięte podczas pracy silnika Errore grave: la pressione non è stata raggiunta mentre il motore è in funzione.</p>





CT-2940/STBT

Authorised Service Center



<https://www.klauke.com/de/en/service-centre-and-repairs>



Declaration of conformity CT-2940/STBT

(D) CE-`21 - Konformitätserklärung. Wir erklären in alleiniger Verantwortlichkeit, dass dieses Produkt mit den folgenden Normen oder normativen Dokumenten übereinstimmt:

EN 62841-1, EN ISO 12100, EN ISO 13857, EN ISO 13854, EN 28662-1, EN 61000-6-3, EN 61000-6-2, EN 1037 gemäß den Bestimmungen der Richtlinien 2006/42/EG, 2014/30/EU, 2011/65/EU

(GB) CE-`21 - Declaration of conformity. We declare under our sole responsibility that this product is in conformity with the following standards or normative documents:

EN 62841-1, EN ISO 12100, EN ISO 13857, EN ISO 13854, EN 28662-1, EN 61000-6-3, EN 61000-6-2, EN 1037 in accordance with the regulations of directives 2006/42/EG, 2014/30/EU, 2011/65/EU

(F) CE-`21 - Déclaration de conformité. Nous déclarons sous notre seule responsabilité que ce produit est en conformité avec les normes ou documents normatifs suivants:

EN 62841-1, EN ISO 12100, EN ISO 13857, EN ISO 13854, EN 28662-1, EN 61000-6-3, EN 61000-6-2, EN 1037 conformément aux réglementations des directives 2006/42/EG, 2014/30/EU, 2011/65/EU

(E) CE-`21 - Declaración de conformidad. Declaramos bajo nuestra sola responsabilidad que este producto está en conformidad con las normas o documentos normativos siguientes:

EN 62841-1, EN ISO 12100, EN ISO 13857, EN ISO 13854, EN 28662-1, EN 61000-6-3, EN 61000-6-2, EN 1037 de acuerdo con las regulaciones de las directivas 2006/42/EG, 2014/30/EU, 2011/65/EU

(I) CE-`21 - Dichiarazione di conformità. Dichiariamo sotto la nostra esclusiva responsabilità che questo prodotto è conforme alle seguenti norme e documenti normativi:

EN 62841-1, EN ISO 12100, EN ISO 13857, EN ISO 13854, EN 28662-1, EN 61000-6-3, EN 61000-6-2, EN 1037 conformemente alle disposizioni delle direttive 2006/42/EG, 2014/30/EU, 2011/65/EU

(P) CE-`21 - Declaração de conformidade. Declaramos sob nossa exclusiva responsabilidade que este produto cumpre as seguintes normas ou documentos normativos:

EN 62841-1, EN ISO 12100, EN ISO 13857, EN ISO 13854, EN 28662-1, EN 61000-6-3, EN 61000-6-2, EN 1037 conforme as disposições das directivas 2006/42/EG, 2014/30/EU, 2011/65/EU

(NL) CE-`21 - Konformiteitsverklaring. Wij verklaren en wij stellen ons er alleen voor verantwoordelijk dat dit product voldoet aan de volgende normen of normatieve documenten:

EN 62841-1, EN ISO 12100, EN ISO 13857, EN ISO 13854, EN 28662-1, EN 61000-6-3, EN 61000-6-2, EN 1037 overeenkomstig de bepalingen van de richtlijnen 2006/42/EG, 2014/30/EU, 2011/65/EU

(GR) CE-`21 - ΔΗΛΩΣΗ ΣΥΜΜΟΡΦΩΣΗΣ Μ. ε αναληψη συνολικης δηλωνομε: οτι το πορον προιον συμφορει με τα παρακατω ποοτυπα και με τα ηροτυπα ηου αναφερονται στα σχετικο εγγραφα

EN 62841-1, EN ISO 12100, EN ISO 13857, EN ISO 13854, EN 28662-1, EN 61000-6-3, EN 61000-6-2, EN 1037 σύμφωνα με τοxς κοινοισμους 2006/42/EG, 2014/30/EU, 2011/65/EU

(S) CE-`21 - Konformitetsdeklaration. Vi förklarar på eget ansvar att denna produkt överensstämmer med följande normer eller normativa dokument:

EN 62841-1, EN ISO 12100, EN ISO 13857, EN ISO 13854, EN 28662-1, EN 61000-6-3, EN 61000-6-2, EN 1037 enligt bestämmelserna i direktiverna 2006/42/EG, 2014/30/EU, 2011/65/EU

(DK) CE-`21 - Konformitetserklæring. Vi erklærer under almindeligt ansvar at dette produkt er i overensstemmelse med følgende normer eller normative dokumenter:

EN 62841-1, EN ISO 12100, EN ISO 13857, EN ISO 13854, EN 28662-1, EN 61000-6-3, EN 61000-6-2, EN 1037 i henhold til bestemmelserne i direktiverne 2006/42/EØF, 2014/30/EU, 2011/65/EU

(N) CE-`21 - Konformitetserklæring. Vi erklærer på eget ansvarlighet at dette produkt er i overensstemmelse med følgende standarder eller standard-dokumenter:

EN 62841-1, EN ISO 12100, EN ISO 13857, EN ISO 13854, EN 28662-1, EN 61000-6-3, EN 61000-6-2, EN 1037 i henhold til bestemmelserne i direktive ne 2006/42/EØF, 2014/30/EU, 2011/65/EU

(FIN) CE-`21 - Todistus standardinmukaisuudesta. Asiasta vastaavana todistamme täten, että tämä tuote on seuraavien standardien ja standardoimisasiakirjojen vaatimusten mukainen:

EN 62841-1, EN ISO 12100, EN ISO 13857, EN ISO 13854, EN 28662-1, EN 61000-6-3, EN 61000-6-2, EN 1037 ja vastaa säädöksiä 2006/42/EG, 2014/30/EU, 2011/65/EU

(SK) CE-`21 - Prehlásenie o zhode. Prehlasujeme na vlastnú zodpovednosť, že tieto produkty sú v súlade s nasledovnými normami:

EN 62841-1, EN ISO 12100, EN ISO 13857, EN ISO 13854, EN 28662-1, EN 61000-6-3, EN 61000-6-2, EN 1037 a v zhode so smernicami 2006/42/EG, 2014/30/EU, 2011/65/EU

(PL) CE-`21 - Zgodność z dyrektywami UKKA. Świadomi odpowiedzialności oświadczamy, że niniejszy produkt jest zgodny z następującymi normami lub dokumentacją normatywną:

EN 62841-1, EN ISO 12100, EN ISO 13857, EN ISO 13854, EN 28662-1, EN 61000-6-3, EN 61000-6-2, EN 1037 zgodnie z postanowieniami wytycznych 2006/42/EG, 2014/30/EU, 2011/65/EU

(CZ) CE-`21 - Prohlášení o shode. Prohlasujeme na vlastní zodpovednosť, že tyto produkty splňují následující normy nebo normativní listiny:

EN 62841-1, EN ISO 12100, EN ISO 13857, EN ISO 13854, EN 28662-1, EN 61000-6-3, EN 61000-6-2, EN 1037; Ve shode se smernicemi 2006/42/EG, 2014/30/EU, 2011/65/EU

(SLO) CE-`21 - Izjava o skladnosti. S tem potrjujemo splošno odgovornost, da je ta izdelek narejen v skladu z navedenimi normami in standardi:

EN 62841-1, EN ISO 12100, EN ISO 13857, EN ISO 13854, EN 28662-1, EN 61000-6-3, EN 61000-6-2, EN 1037 ter določbami in smernicami 2006/42/EG, 2014/30/EU, 2011/65/EU

(HR) CE-`21 - Izjava o skladnosti. Pod punom odgovornošću izjavljujemo da je proizvod naveden u naslovu ovog dokumenta sukladan sa primijenjenim normama i normativnim dokumentima:

EN 62841-1, EN ISO 12100, EN ISO 13857, EN ISO 13854, EN 28662-1, EN 61000-6-3, EN 61000-6-2, EN 1037 u skladu sa odredbama preporuka 2006/42/EG, 2014/30/EU, 2011/65/EU

(H) CE-`21 - Megfelelőségi nyilatkozat. Kéziműködtetésű elektromos kéziszerszámok: Teljes felelősséggel kijelentjük, hogy ezek a termékek a következő szabványokkal és irányelvekkel összhangban vannak:

EN 62841-1, EN ISO 12100, EN ISO 13857, EN ISO 13854, EN 28662-1, EN 61000-6-3, EN 61000-6-2, EN 1037; és megfelelnek a rendeltetés szerinti 2006/42/EG, 2014/30/EU, 2011/65/EU irányelveknek.

(RO) CE-`21 - Declarație de conformitate. Noi declarăm pe propria răspundere că acest produs este în conformitate cu următoarele norme și documente normative:

EN 62841-1, EN ISO 12100, EN ISO 13857, EN ISO 13854, EN 28662-1, EN 61000-6-3, EN 61000-6-2, EN 1037; potrivit dispozițiilor directivelor 2006/42/EG, 2014/30/EU, 2011/65/EU

Remscheid, 02.11.2021



Joh. - Christoph Schütz

Dipl.-Ing. Joh.-Christoph Schütz, CE-Representative

Declaration of conformity CT-2940/STBT

(D) CE-'21 - Konformitätserklärung **RED**. Wir erklären in alleiniger Verantwortlichkeit, daß dieses Produkt mit den folgenden Normen oder normativen Dokumenten übereinstimmt:

EN 62368-1, EN 301489-1, EN 301489-17, EN 300328 V2.2.2, EN 62479 gemäß den Bestimmungen der Richtlinien 2014/53/EU, 2011/65/EU

(GB) CE-'21 - Declaration of conformity **RED**. We declare under our sole responsibility that this product is in conformity with the following standards or normative documents:

EN 62368-1, EN 301489-1, EN 301489-17, EN 300328 V2.2.2, EN 62479 in accordance with the regulations of directives 2014/53/EU, 2011/65/EU

(F) CE-'21 - Déclaration de conformité **RED**. Nous déclarons sous notre seule responsabilité que ce produit est en conformité avec les normes ou documents normatifs suivants:

EN 62368-1, EN 301489-1, EN 301489-17, EN 300328 V2.2.2, EN 62479 conformément aux réglementations des directives 2014/53/EU, 2011/65/EU

(E) CE-'21 - Declaración de conformidad **RED**. Declaramos bajo nuestra sola responsabilidad que este producto está en conformidad con las normas o documentos normativos siguientes:

EN 62368-1, EN 301489-1, EN 301489-17, EN 300328 V2.2.2, EN 62479 de acuerdo con las regulaciones de las directivas 2014/53/EU, 2011/65/EU

(I) CE-'21 - Dichiarazione di conformità **RED**. Dichiariamo sotto la nostra esclusiva responsabilità che questo prodotto è conforme alle seguenti norme e documenti normativi:

EN 62368-1, EN 301489-1, EN 301489-17, EN 300328 V2.2.2, EN 62479 conformemente alle disposizioni delle direttive 2014/53/EU, 2011/65/EU

(P) CE-'21 - Declaração de conformidade **RED**. Declaramos sob nossa exclusiva responsabilidade que este produto cumpre as seguintes normas ou documentos normativos:

EN 62368-1, EN 301489-1, EN 301489-17, EN 300328 V2.2.2, EN 62479 conforme as disposições das directivas 2014/53/EU, 2011/65/EU

(NL) CE-'21 - Konformiteitsverklaring **RED**. Wij verklaren en wij stellen ons er alleen voor verantwoordelijk dat dit produkt voldoet aan de volgende normen of normatieve documenten:

EN 62368-1, EN 301489-1, EN 301489-17, EN 300328 V2.2.2, EN 62479 overeenkomstig de bepalingen van de richtlijnen 2014/53/EU, 2011/65/EU

(GR) CE-'21 - ΔΗΛΩΣΗ ΣΥΜΜΟΡΦΩΣΗΣ Μ **RED**. ε αναληψη συνολικης δηλωνομε οτι το πορον προιον συμφωνει με τα παρακατω ποσοτυπα και με τα ηροτυπα ηου αναφερονται στα σχεπκο εγγραφα

EN 62368-1, EN 301489-1, EN 301489-17, EN 300328 V2.2.2, EN 62479 σύμφωνα με τοχς κονονισμοϋς 2014/53/EU, 2011/65/EU

(S) CE-'21 - Konformitetsdeklaration **RED**. Vi förklarar på eget ansvar att denna produkt överensstämmer med följande normer eller normativa dokument:

EN 62368-1, EN 301489-1, EN 301489-17, EN 300328 V2.2.2, EN 62479 enligt bestämmelserna i direktiverna 2014/53/EU, 2011/65/EU

(DK) CE-'21 - Konformitetserklæring **RED**. Vi erklærer under almindeligt ansvar at dette produkt er i overensstemmelse med følgende normer eller normative dokumenter:

EN 62368-1, EN 301489-1, EN 301489-17, EN 300328 V2.2.2, EN 62479 i henhold til bestemmelserne i direktiverne 2014/53/EU, 2011/65/EU

(N) CE-'21 - Konformitetserklæring **RED**. Vi erklærer på eget ansvarlighet at dette produkt er i overensstemmelse med følgende standarder eller standard-dokumenter:

EN 62368-1, EN 301489-1, EN 301489-17, EN 300328 V2.2.2, EN 62479 i henhold til bestemmelserne i direktive ne 2014/53/EU, 2011/65/EU

(FIN) CE-'21 - Todistus standardinmukaisuudesta **RED**. Asiasta vastaava todistamme täten, että tämä tuote on seuraavien standardien ja standardoimisasiakirjojen vaatimusten mukainen:

EN 62368-1, EN 301489-1, EN 301489-17, EN 300328 V2.2.2, EN 62479 ja vastaa säädöksiä 2014/53/EU, 2011/65/EU

(SK) CE-'21 - Prehlásenie o zhode **RED**. Prehlasujeme na vlastnú zodpovednosť, že tieto produkty sú v súlade s nasledovnými normami: EN 62368-1, EN 301489-1, EN 301489-17, EN 300328 V2.2.2, EN 62479 a v zhode so smernicami 2014/53/EU, 2011/65/EU

(PL) CE-'21 - Zgodność z dyrektywami **RED**. Świadomi odpowiedzialności oświadczamy, że niniejszy produkt jest zgodny z następującymi normami lub dokumentacją normatywną: EN 62368-1, EN 301489-1, EN 301489-17, EN 300328 V2.2.2, EN 62479 zgodnie z postanowieniami wytycznych 2014/53/EU, 2011/65/EU

(CZ) CE-'21 - Prohlášení o shode **RED**. Prohlasujeme na vlastní zodpovednosť, že tyto produkty splňují následující normy nebo normativní listiny: EN 62368-1, EN 301489-1, EN 301489-17, EN 300328 V2.2.2, EN 62479 Ve shode se smernicemi 2014/53/EU, 2011/65/EU

(SLO) CE-'21 - Izjava o skladnosti **RED**. S tem potrjujemo splošno odgovornost, da je ta izdelek narejen v skladu z navedenimi normami in standardi EN 62368-1, EN 301489-1, EN 301489-17, EN 300328 V2.2.2, EN 62479 ter določbami in smernicami 2014/53/EU, 2011/65/EU

(HR) CE-'21 - Izjava o skladnosti **RED**. Pod punom odgovornošću izjavljujemo da je proizvod naveden u naslovu ovog dokumenta sukladan sa primijenjenim normama i normativnim dokumentima : EN 62368-1, EN 301489-1, EN 301489-17, EN 300328 V2.2.2, EN 62479 u skladu sa odredbama preporuka 2014/53/EU, 2011/65/EU

(H) CE-'21 - Megfelelősségi nyilatkozat **RED**. Kéziműködtetésű elektromos kéziszerszámok. Teljes felelősséggel kijelentjük, hogy ezek a termékek a következő szabványokkal és irányelvekkel összhangban vannak: EN 62368-1, EN 301489-1, EN 301489-17, EN 300328 V2.2.2, EN 62479 és megfelelnek a rendeltetés 2014/53/EU, 2011/65/EU irányelveknek.

(RO) CE-'21 - Declarație de conformitate **RED**. Noi declarăm pe propria răspundere că acest produs este în conformitate cu următoarele norme și documente normative: EN 62368-1, EN 301489-1, EN 301489-17, EN 300328 V2.2.2, EN 62479 potrivit dispozițiilor directivelor 2014/53/EU, 2011/65/EU

Remscheid, 01.06.2021



Joh. - Christoph Schütz

Dipl.-Ing. Joh.-Christoph Schütz, CE-Representative

Blackfin Tools Certificate of Calibration

Subject: Panduit BlackFin Series **

The Panduit BlackFin tools have completed the following Testing criteria in the Factory before shipped.

Checklist Final Inspection

1. Final Inspection (type, serial number, product group, etc.)
2. Check head for stop or locking
3. Check the pressure with the housing closed
4. Check if all screws are installed
5. Check whether the machine is "reset"
6. Check if a warning sticker is attached
7. Check whether the inspection sticker is attached
8. Check the cleanliness (oil leakage, case, etc.)
9. Check whether the accessories are complete
10. Check whether the desired test reports are attached (TQ16, etc.)
11. The final inspection is carried out by the Service Center Goods Department

The user of the Panduit product is responsible for verifying suitability of the product for the application and assumes all risk and liability in connection with its use.

Our most important connection is with you.

We have the knowledge and experience to help you make the most of your infrastructure investment.

www.panduit.com

Let's Connect

P: 800-777-3300 :: F: 708-532-1811

www.panduit.com/en/support/contact-us.html

HE.20206_A

PANDUIT™
infrastructure for a connected world