

THIS COPY IS PROVIDED ON A RESTRICTED BASIS AND IS NOT TO BE USED IN ANY WAY DETRIMENTAL TO THE INTERESTS OF PANDUIT CORP.

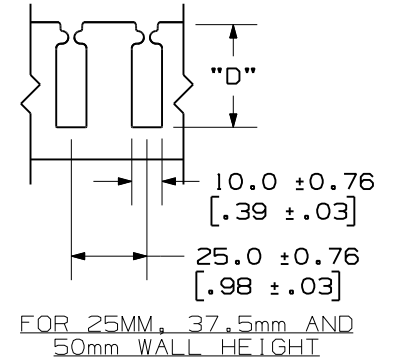
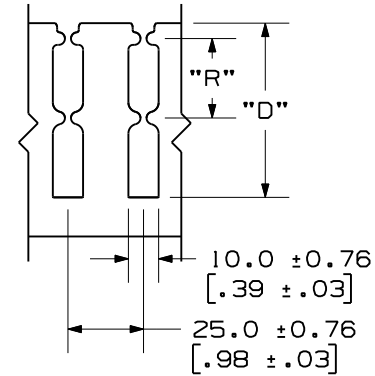
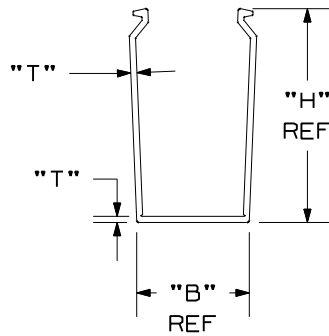
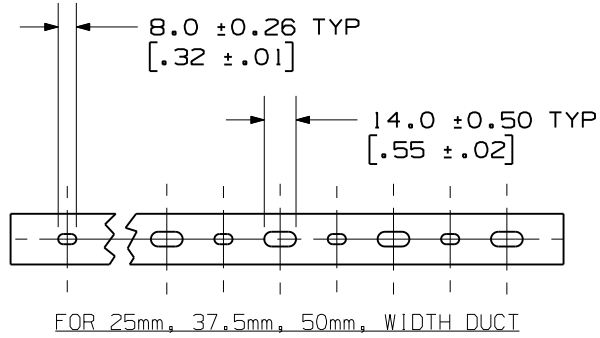

FOR 75mm AND 100mm WALL HEIGHT

SIDE WALL DIMENSIONS

NOTES:

- "B" MEASURED AT BASE.
- STANDARD LENGTH: 2.004 METER.
- SEE CURRENT CATALOG FOR PART NUMBER DESIGNATIONS FOR TYPE, COLOR, AND LENGTH.
- DUCT TYPE "TNC" PACKAGED WITH TYPE "TNC" COVER.
- DIMENSIONS ARE METRIC (INCHES).

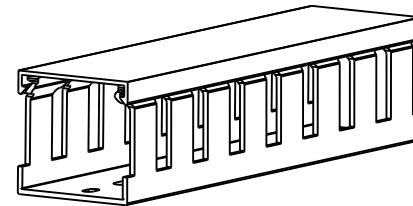
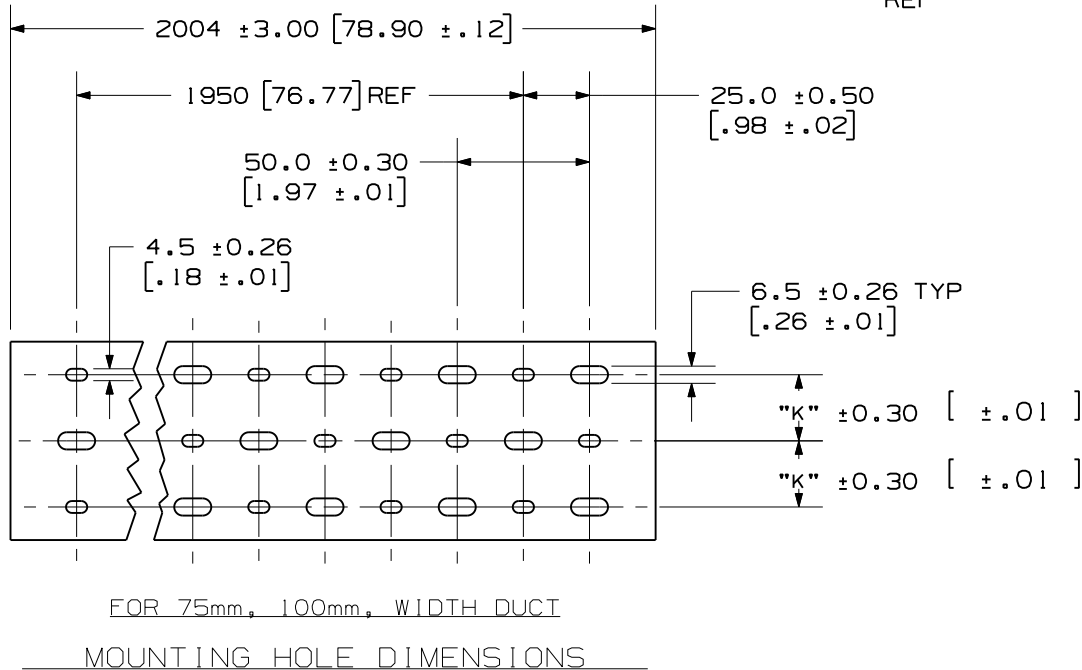

CHANNEL EXAMPLE:
TNC 37 X 50 LG 2
TYPE WIDE HIGH COLOR (LIGHT GRAY) LENGTH (m)

REV	DATE	BY	CHK	APR	DESCRIPTION	ECN
1	2/1/12	JCST	MRJS	RAMI	A. CORRECTED "T" DIMENSION (SHT 2) (25X37, 25X75, 50X100, 100X75, 100X100)	38539AG-DC
R	11/7/11	JCST	MRJS	RAMI	DRAWING RELEASED TO PRODUCTION	38539AG-DC

TITLE						
WIRING DUCT AND COVER TYPE "TNC" METRIC						
CUSTOMER DRAWING						
ITEM REVISION						
DATASET FILE NAME D38539AG_DC_TNC/00A						
UNLESS OTHERWISE SPECIFIED, DIMENSIONAL TOLERANCES ARE: mm (IN)						
.x : 2.54 (.1)			.xxx : .127 (.005)			
.xx : .25 (.01)			ANGLES : 5 °			
			THIRD ANGLE PROJECTION			
DRAWN BY	DATE	CHK	SCALE	MATERIAL:		
JCST	10/24/11	MRJS	NONE	LOW-SMOKE HALOGEN-FREE MODIFIED PPE-HIPS BLEND		
DRAWING NUMBER:				38539AG-DC		
SHT 1 OF 3				SIZE A		

D10100DA/08

2

1

THIS COPY IS PROVIDED ON A RESTRICTED BASIS AND IS NOT TO BE USED IN ANY WAY DETRIMENTAL TO THE INTERESTS OF PANDUIT CORP.



PROFILE DIMENSION				
NOMINAL DUCT SIZE (W X H)	B REF	H REF	T	T TOL.
* 25 X 25	24.6 (.97)	20.5 (.81)	1.4 (.06)	±.26 (.010)
25 X 37	24.6 (.97)	33.0 (1.30)	1.8 (.07)	±.26 (.010)
* 25 X 50	24.6 (.97)	45.5 (1.79)	2.0 (.08)	±.30 (.012)
25 X 75	24.6 (.97)	70.5 (2.78)	2.0 (.08)	±.30 (.012)
37 X 37	37.1 (1.46)	33.0 (1.30)	1.8 (.07)	±.30 (.012)
* 37 X 50	37.1 (1.46)	45.5 (1.79)	2.0 (.08)	±.30 (.012)
37 X 75	37.1 (1.46)	70.5 (2.78)	2.0 (.08)	±.36 (.014)
50 X 50	49.6 (1.95)	45.5 (1.79)	2.0 (.08)	±.30 (.012)
* 50 X 75	49.6 (1.95)	70.5 (2.78)	2.0 (.08)	±.36 (.014)
* 50 X 100	49.6 (1.95)	95.5 (3.76)	2.3 (.09)	±.40 (.016)
75 X 75	74.6 (2.94)	70.5 (2.78)	2.0 (.08)	±.40 (.016)
100 X 50	99.6 (3.92)	45.5 (1.79)	2.0 (.08)	±.40 (.016)
100 X 75	99.6 (3.92)	70.5 (2.78)	2.0 (.08)	±.50 (.020)
* 100 X 100	99.6 (3.92)	95.5 (3.76)	2.3 (.09)	±.50 (.020)

* = NON-STANDARD SIZE

MOUNTING HOLE	
NOMINAL DUCT WIDTH	K ±.5 (.02)
25	----
37	----
50	----
75	25.0 (.98)
100	25.0 (.98)

SLOT DIMENSION		
NOMINAL DUCT HEIGHT	D ±.8 (.03)	R ±.75 (.02)
25	13.6 (.54)	-----
37	24.7 (.97)	-----
50	34.8 (1.37)	-----
75	57.6 (2.27)	26.26 (1.03)
100	81.0 (3.19)	38.0 (1.50)

ALL DIMENSIONS ARE MM (IN).

REV	DATE	BY	CHK	APR	DESCRIPTION	ECN
1	2/1/12	JCST	MRJS	RAMI	SEE SHEET 1 FOR REVISIONS	38539AG-DC
R	11/7/11	JCST	MRJS	RAMI	SEE SHEET 1 FOR REVISIONS	38539AG-DC

TITLE WIRING DUCT AND COVER TYPE "TNC" METRIC					
CUSTOMER DRAWING					
ITEM REVISION			PANDUIT TM		
DATASET FILE NAME D38539AG_DC_TNC/00A					
UNLESS OTHERWISE SPECIFIED, DIMENSIONAL TOLERANCES ARE: mm (IN) .x : 2.54 (.1) .xxx : .127 (.005) .xx : .25 (.01) ANGLES : 5 °			MATERIAL : LOW-SMOKE HALOGEN-FREE MODIFIED PPE-HIPS BLEND		
DRAWN BY JCST			DRAWING NUMBER: 38539AG-DC		
DATE 10/24/11		CHK MRJS		SCALE NONE	
THIRD ANGLE PROJECTION		SHT 2 OF 3		SIZE A	

2

1

D10100DA/08

THIS COPY IS PROVIDED ON A RESTRICTED BASIS AND IS NOT TO BE USED IN ANY WAY DETRIMENTAL TO THE INTERESTS OF PANDUIT CORP.

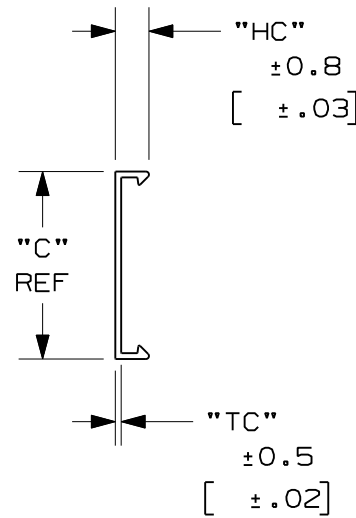
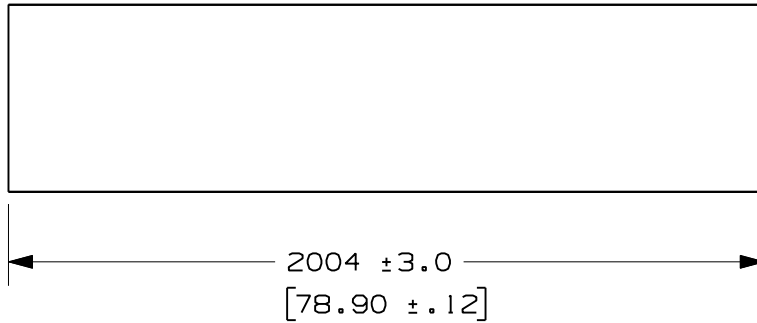

NOMINAL DUCT SIZE (W)	C REF	HC	TC
25	24.6 (.97)	8.9 (.35)	1.30 (.05)
37	37.1 (1.46)	8.9 (.35)	1.30 (.05)
50	49.6 (1.95)	8.9 (.35)	1.40 (.06)
75	74.6 (2.94)	9.4 (.37)	1.40 (.06)
100	99.6 (3.92)	9.4 (.37)	1.40 (.06)

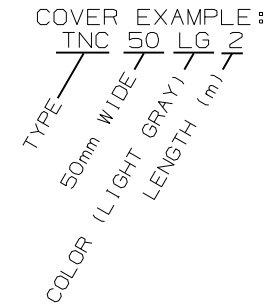

ALL DIMENSIONS ARE MM (IN).

REV	DATE	BY	CHK	APR	DESCRIPTION	ECN
1	2/1/12	JCST	MRJS	RAMI	SEE SHEET 1 FOR REVISIONS	38539AG-DC
R	11/7/11	JCST	MRJS	RAMI	SEE SHEET 1 FOR REVISIONS	38539AG-DC

TITLE WIRING DUCT AND COVER TYPE "TNC" METRIC CUSTOMER DRAWING					
ITEM REVISION					
DATASET FILE NAME D38539AG_DC_TNC/00A					
UNLESS OTHERWISE SPECIFIED, DIMENSIONAL TOLERANCES ARE: mm (IN) .x : 2.54 (.1) .xxx : .127 (.005) .xx : .25 (.01) ANGLES : 5 °				MATERIAL: LOW-SMOKE HALOGEN-FREE MODIFIED PPE-HIPS BLEND	
DRAWN BY: JCST DATE: 10/24/11 CHK: MRJS SCALE: NONE				DRAWING NUMBER: 38539AG-DC	
THIRD ANGLE PROJECTION				SHT 3 OF 3	
				SIZE A	

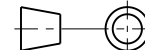

THIRD ANGLE PROJECTION

D10100DA/08