

NOTE:
Steps 1-5 show cable preparation method for TX6A Cable with MaTriX Technology, similar for other cables.

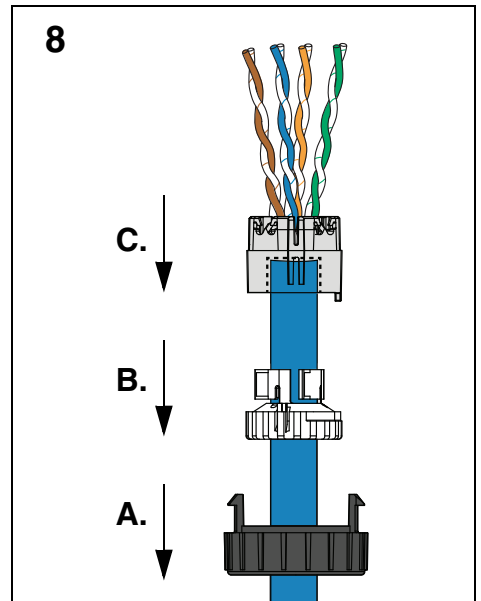

9 T568B Wiring

Cable End 1

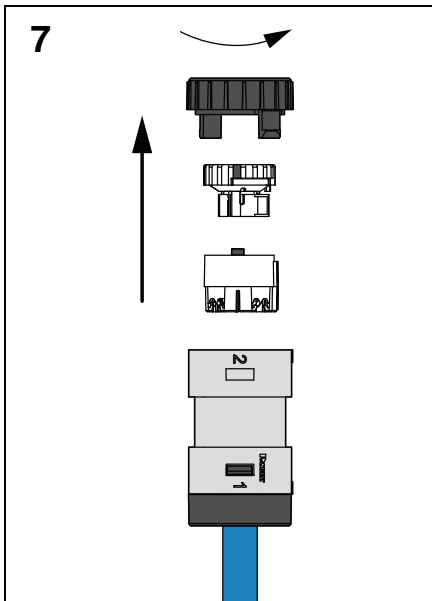
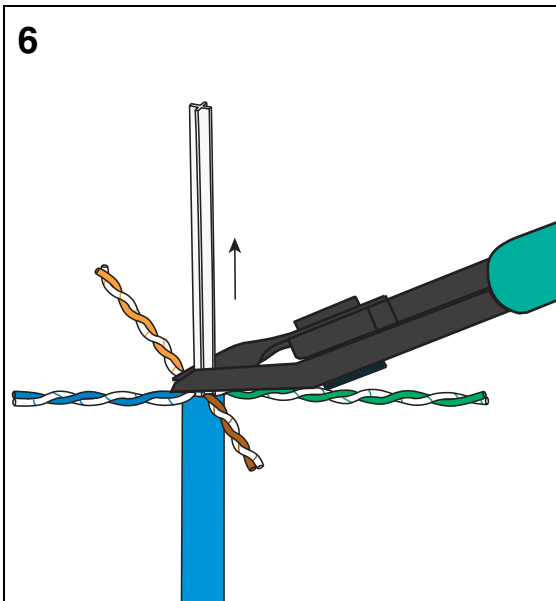
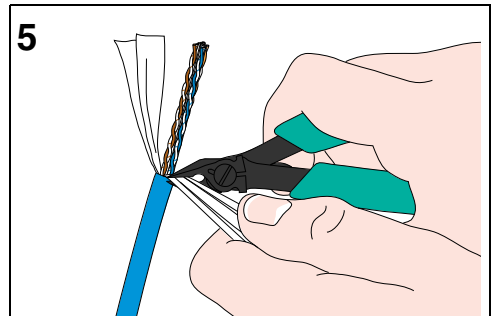
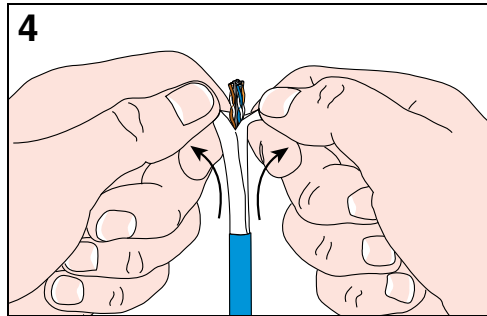
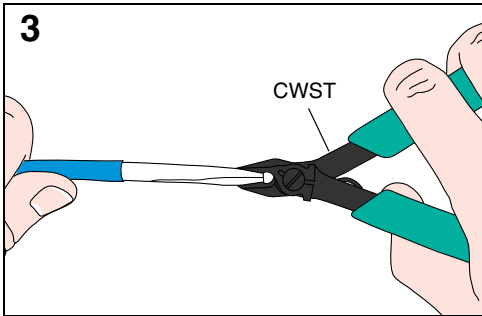
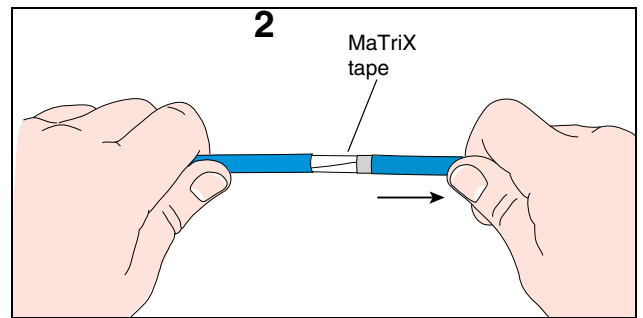
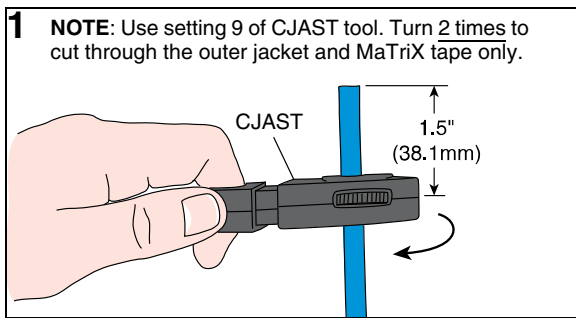
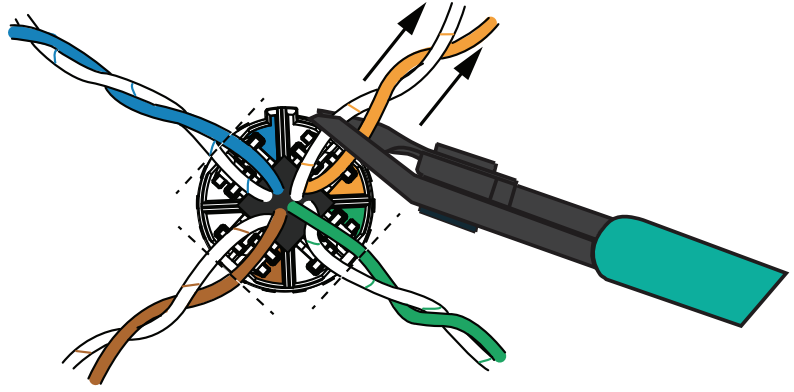
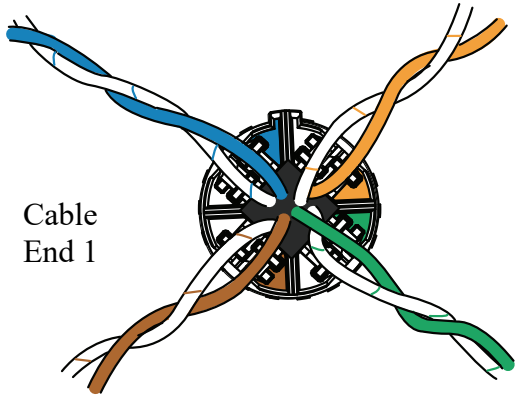

Cable End 2

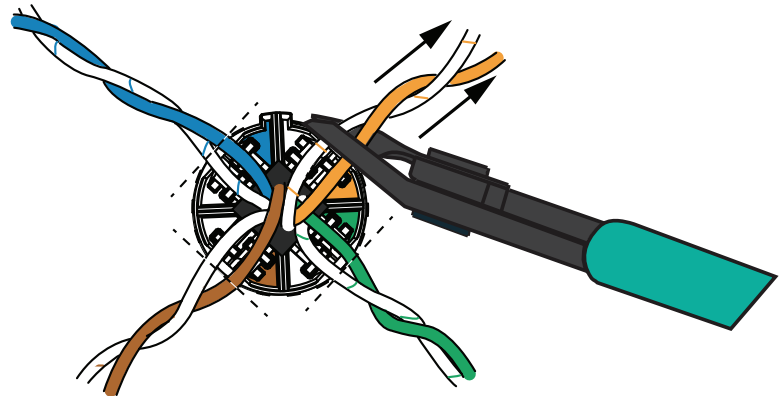
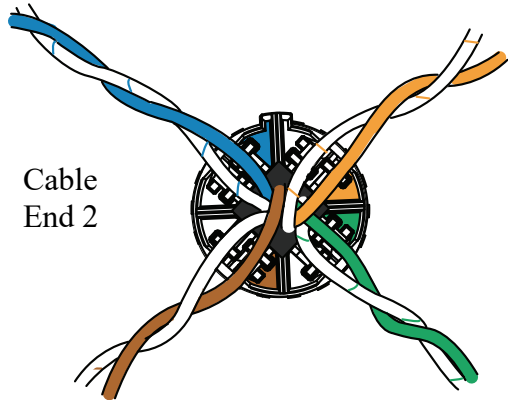

9b T568A Wiring

Cable End 1

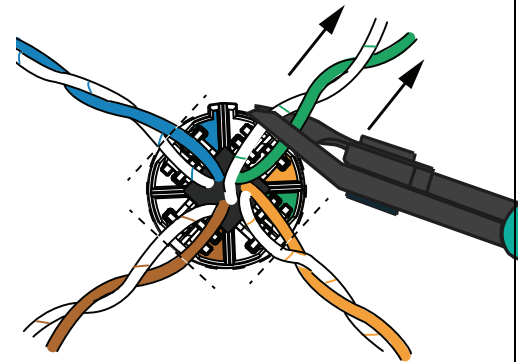
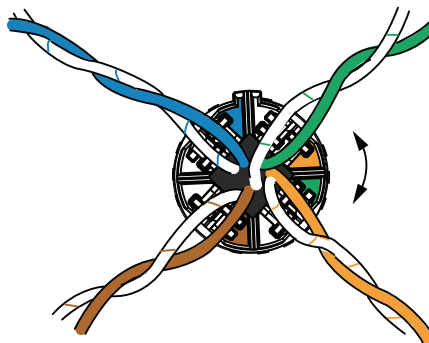
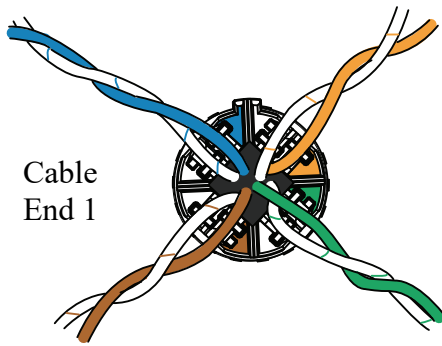

Cable End 2

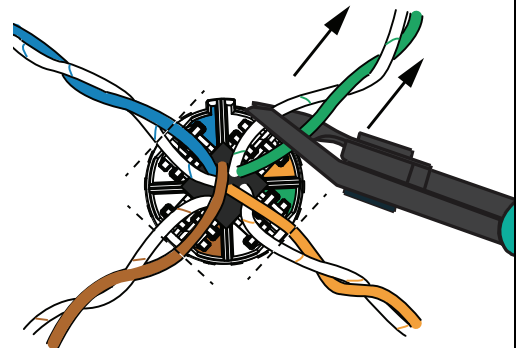
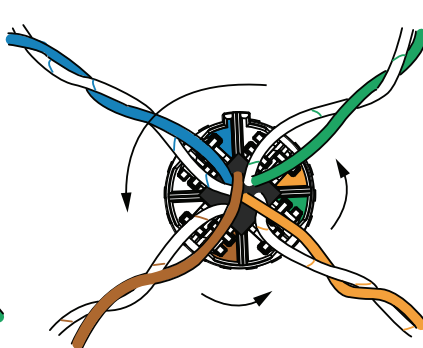
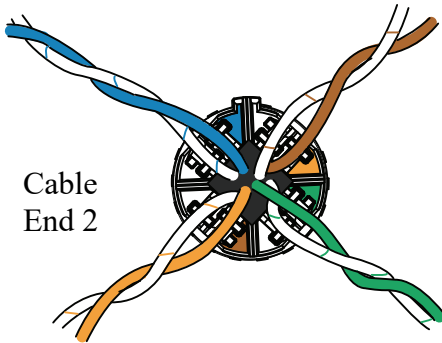

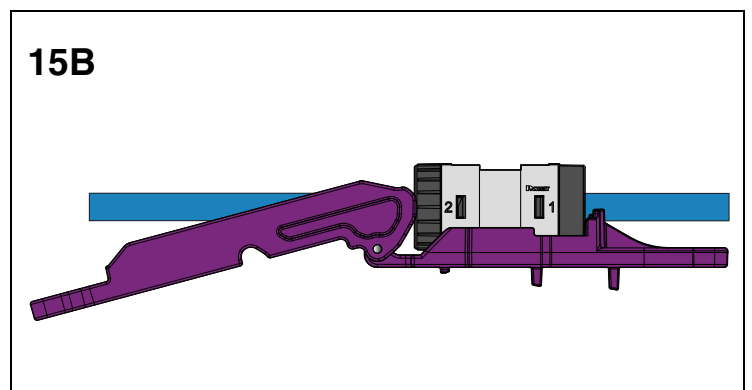
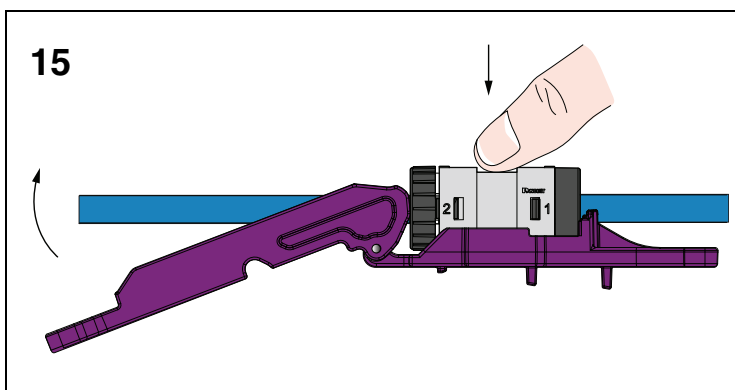
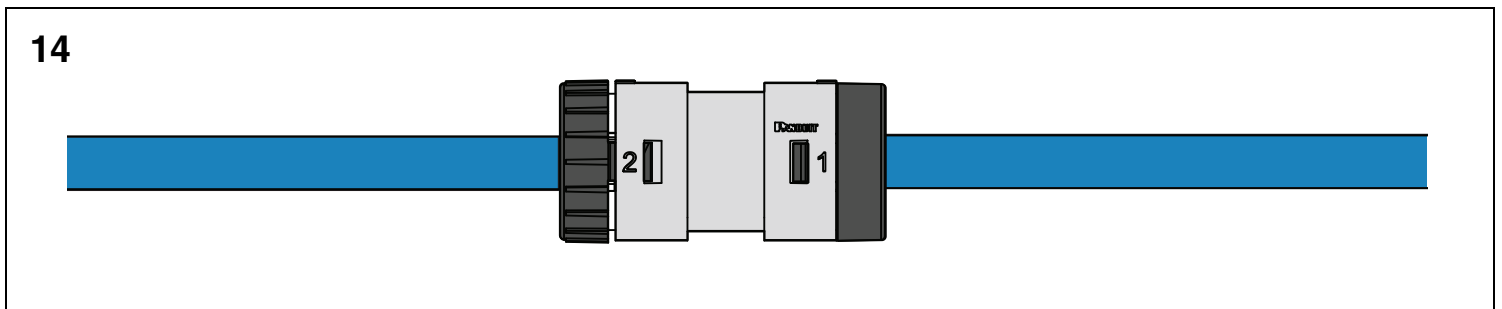
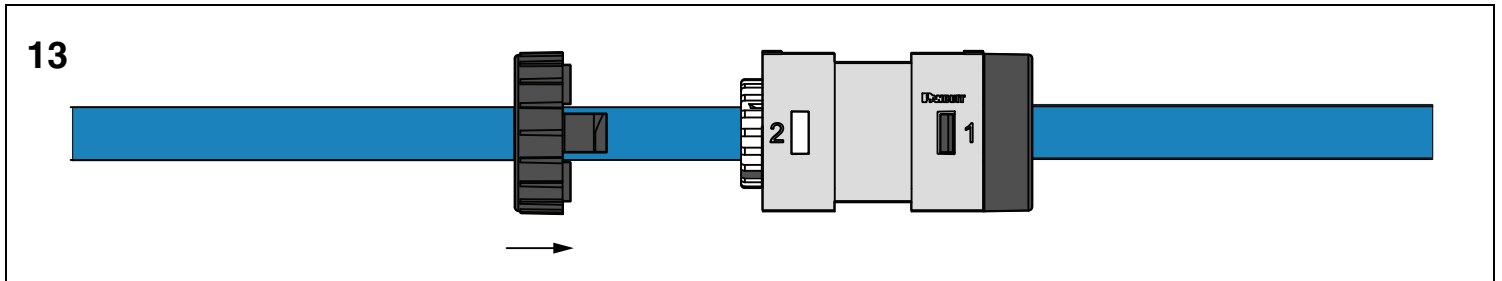
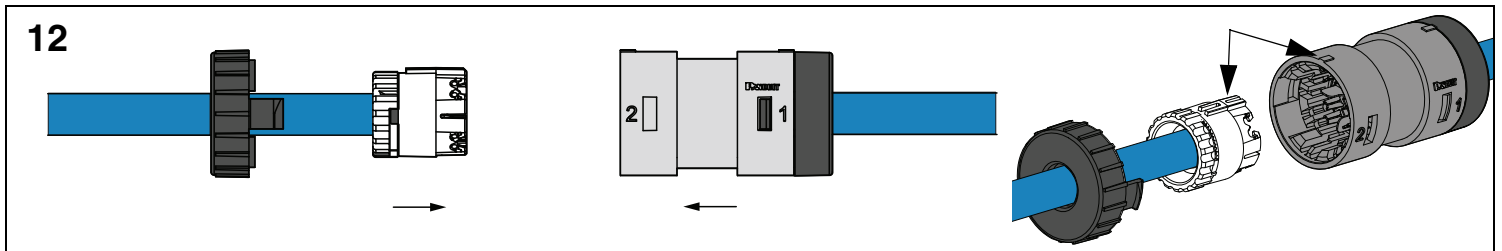
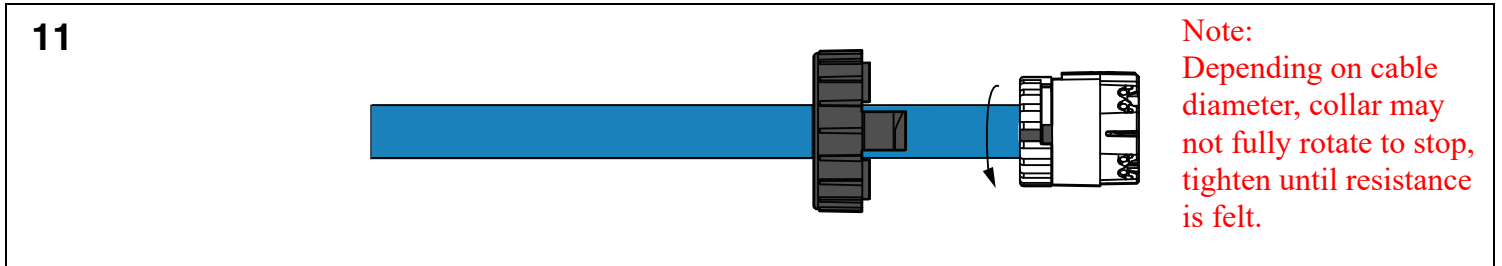
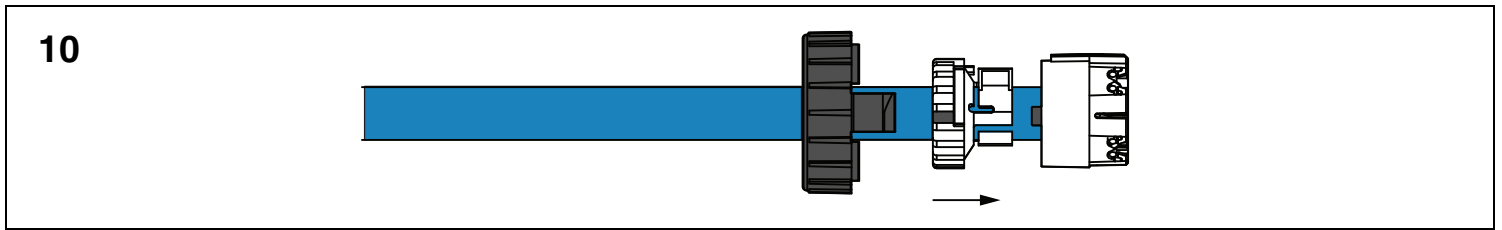

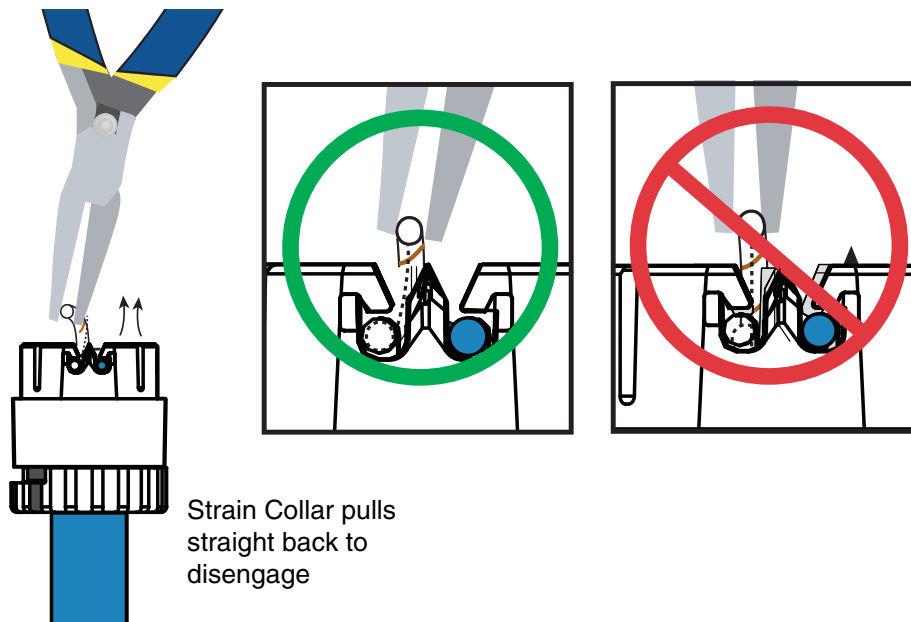
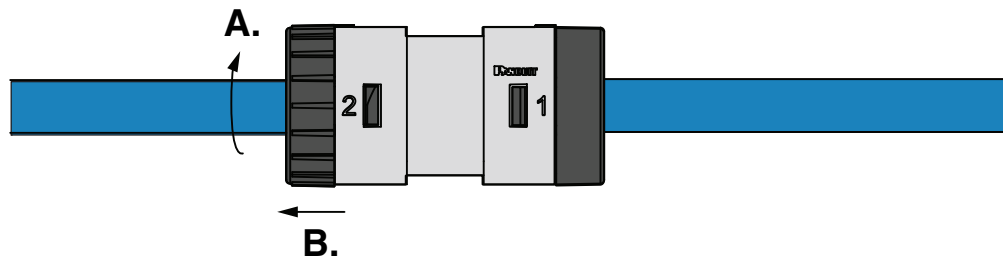
REMOVAL STEPS**Notes:**

1. For specified performance, follow TIA/EIA 568.2-D installation guidelines.
2. Splice module can terminate 22-26 AWG solid or stranded IWC data cable with 0.060" (1.52mm) maximum insulated conductor outside diameter.
3. Splice module may be re-terminated up to 20 times.
4. For technical and performance information, consult Panduit technical support.

As with all Wiring Accessories, the following statements apply:

1. Never install communications wiring during a lightning storm.
2. Never install communications wiring in wet locations unless the plug is specifically designed for use in wet locations.
3. Never touch uninsulated communications wiring or terminals unless the communication line has been disconnected at the network interface.
4. Use caution when installing or modifying communication wiring.



Intertek
5020430
Conforms to UL
STD 1863.
Certified to CSA
STD C22.2#233

For Instructions in Local Languages
and Technical Support:

www.panduit.com/resources/install_maintain.asp

PANDUIT
www.panduit.com

E-mail:
techsupport@panduit.com

Phone:
866-405-6654