

THIS COPY IS PROVIDED ON A RESTRICTED BASIS AND IS NOT TO BE USED IN ANY WAY DETRIMENTAL TO THE INTERESTS OF PANDUIT CORP.

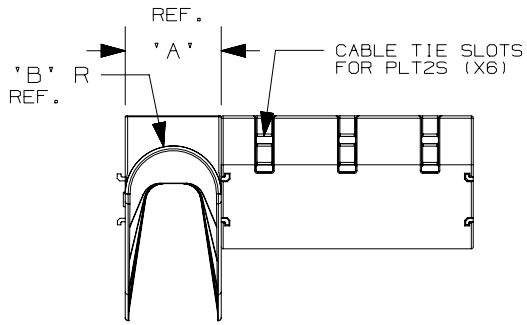

PANDUIT * PART NO.	DIMENSIONS										WEIGHT lbs. (grams)
	A	B	C	D	E	F	G	H	J		
CMW-KIT10	2.00 [50.8]	1.00 [25.4]	5.25 [133.4]	9.58 [243.3]	1.75 [44.4]	3.00 [76.2]	1.20 [30.5]	3.33 [84.6]	4.87 [124.5]		.606 (274.9)
CMWB10	—	—	5.24 [133.4]	—	1.75 [44.4]	—	1.20 [30.5]	—	—		.230 (104.3)
CMWW10	2.00 [50.8]	1.00 [25.4]	—	—	—	3.00 [76.2]	—	3.33 [84.6]	4.87 [124.5]		.188 (85.3)

Notes:

1. See current price sheet for part number suffix designation for package size and color.
2. Flame retardant cable ties (Qty. 3, PLT2S-M60) included with CMWB and CMW-KIT10.
3. Dimensions in Brackets are METRIC (mm).

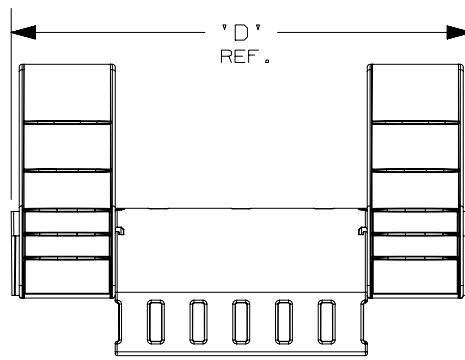
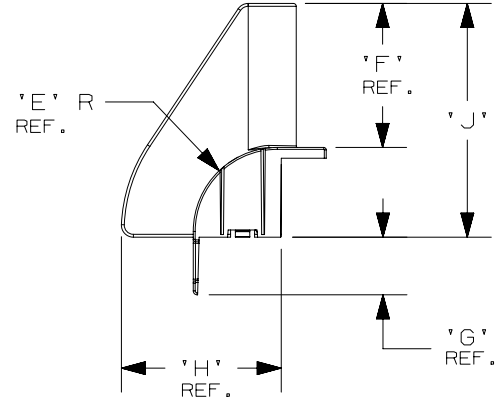
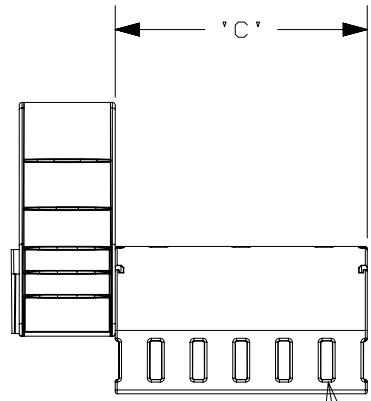
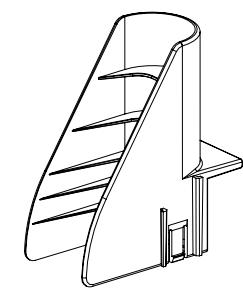
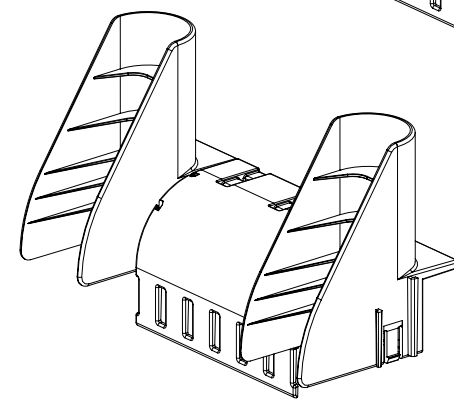
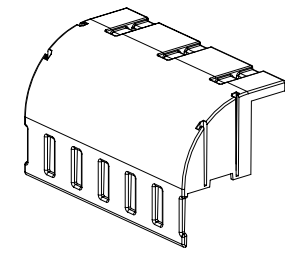

TITLE									
CABLE MANAGEMENT WATERFALL									
CUSTOMER DRAWING									
ITEM REVISION NAME					G03597ES/03				
DATASET FILE NAME					G03597ES_DC_GB0239IT/03A				
					THIRD ANGLE PROJECTION				
MATERIAL					GLASS FILLED, NYLON 66, WHITE				
DRAWING NUMBER					GB0239IT				
DRAWN BY	DATE	CHK	SCALE						
LGG	8/27/01	-	1/4						
SHEET 1 OF 1									
A									

REV	DATE	BY	CHK	APR	DESCRIPTION	ECN
03A	3/30/22	JSP	DWR	ML	C. MATERIAL WAS GLASS REINFORCED FLAME RETARDANT NYLON 6/6 A. UPDATED TITLE BLOCK B. TRANSFERRED NOTE 3 FROM TITLE BLOCK	GB0239IT
1	4/17/03	LGG			CHG DIM C & D FOR CMW-KIT WAS 5.24 (133.4) & 9.60 (243.3)/ ADD 'REF' TO DIM 'A'	GB0239IT

A-SIZE CUSTOMER