**Preferred Parts for
Network Infrastructure**



South Asia

Network Infrastructure

Today's networks support ever-expanding converged applications for voice, data, and video, as well as functions such as intelligent lighting, security, safety systems, and more. Panduit™ provides the industry's most comprehensive and holistic portfolio of products and services that enable sustainable, energy-efficient enterprises. Innovative design features provide easy installation, reduced maintenance costs, and improved network reliability and flexibility. This catalog features the preferred offering for both physical infrastructure and the intelligence to solve the most challenging business problems customers face as they connect multiple systems that span from the Enterprise to the Data Center and across the Manufacturing floor. For the complete offering, please contact your local Panduit representative or visit us at www.panduit.com.

Table of Contents

Enterprise

Copper Cable	3
RJ45 Jack Module	3
Patch Panels, Kits and Accessories	4
Field Term RJ45 Plug	4
RJ45 Patch Cords	5
Faceplate	6
Blank Modules	6
Fibre Optic Cable – Indoor	6
Fibre Optic Cable – Indoor/Outdoor	6
Fibre Optic Cable – Outdoor	6
Fibre Patch Cords	7
Fibre Enclosures	7
Fibre Adapter Modules and Panels	8
Fibre Pigtail Sets	8
Cabinets	8
Racks, Shelves and Accessories	9
Cable Managers	9
Cable Manager Capacity Chart	10
Blanking Panels	10
Labeling	11
Tools	11
Fibre Optic Termination Tools	11

Data Centre

OM4 12-Fibre MPO-LC Cassette	12
OM4 12-Fibre MPO Interconnect	12
PanMPO™ Fibre Connector	13
10G to 40G Migration	13
10G Method A with PanMPO™	13
40G Method B with PanMPO™	13
OS2 12-Fibre MPO-LC Cassette	14
OS2 12-Fibre MPO Interconnect, Method A	14
QuickNet™ Cassette Patch Panels	15
QuickNet™ Accessories	15
HD Flex™ Fibre Cabling System Panels	15
HD Flex™ Cable Managers	15
OM4-24 FibreMPO Trunk	16
QuickNet™ Copper Category 6A Small Diameter	17
OM4 LC-LC Patch Cords	18
OS2 LC-LC Patch Cords	18
Category 6A Patch Cords	18
10Gig SFP+ Direct Attach Passive Copper Cable Assemblies	19
Security Devices	19
Cabinets	20
Power Distribution Units (PDUs)	21
Wyr-Grid™ Overhead Cable Tray Routing System	21
FiberRunner™ System	22
Cable Ties and Bundling	23
Cable Accessories	23

Industrial Networks

IndustrialNet™ Copper Cable	24
IndustrialNet™ RJ45 Patch Cords	24
IndustrialNet™ IP67 RJ45 Patch Leads	24
IndustrialNet™ Connectors	25
Field Term RJ45 Plug	25
DIN Rail Mount Enclosures and Accessories	26
Industrial Network Uninterruptible Power Supply (UPS)	26
Industrial Network Zone Enclosures	27

Enterprise

Copper Cable

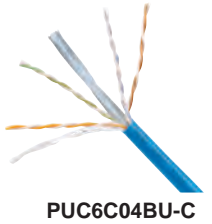

Part Number	Description	UOM	MOQ
Unshielded			
PUL6AV04WH-EG	Category 6A VariMaTrix, U/UTP cable, 23 AWG, White, LSZH, 305m.	Reel	24
PUC6C04BU-C	Category 6 U/UTP cable, 24 AWG, Blue, CM, 305m.	Box	20
PUC6004BU-FE	Category 6 U/UTP cable, 23 AWG, Blue, CM, 305m.	Box	24
Shielded			
PFL6X04BU-CEG	Category 6A F/UTP cable, 23 AWG, Blue, LSZH, 305m.	Reel	18

Note: F/UTP means Foil around Unshielded Twisted Pairs = shielded cable.
LSZH means Low Smoke Zero Halogen.

RJ45 Jack Module



Part Number	Description	Std. Pkg. Qty.	Std. Ctn. Qty.
Unshielded			
CJ6X88TG**	Category 6A RJ45 UTP Mini-Com™ Jack.	1	50
CJLR6X88TG**	Category 6A RJ45 UTP Mini-Com™ Jack, 45 degree left/right termination cap.	1	50
CJUD6X88TG**	Category 6A RJ45 UTP Mini-Com™ Jack, 45 degree up/down termination cap.	1	50
Shielded			
CJ688TG**	Category 6 RJ45 UTP Mini-Com™ Jack.	1	50
CJLR688TG**	Category 6 RJ45 UTP Mini-Com™ Jack, 45 degree left/right termination cap.	1	50
CJUD688TG**	Category 6 RJ45 UTP Mini-Com™ Jack, 45 degree up/down termination cap.	1	50
CJS6X88TGY	Category 6A RJ45 shielded Mini-Com™ Jack, Black.	1	50

**Denotes jack colour.

BL = black, BU = Blue, IW = international White, RD = Red, GR = Green, YL = Yellow, OR = Orange
Contact customer service for other colours and bulk packs.

Termination Cap

Left/Right



CJLRCAPBU-X	Category 6A 45° angled left/right TG wire cap, Blue.	10	100
CJLRCAPIW-X	Category 6 45° angled left/right TG wire cap, International White.	10	100
CJSLRCAPBU-X	Category 6A shielded 45° angled left/right TG wire cap, Blue.	10	100

Up/Down



CJUDCAPBU-X	Category 6A 45° angled up/down TG wire cap, Blue.	10	100
CJUDCAPIW-X	Category 6 45° angled up/down TG wire cap, International White.	10	100
CJSUDCAPBU-X	Category 6A shielded 45° angled up/down TG wire cap, Blue.	10	100
CPUDCAPBL-X	Category 6A 45° angled up/down wire cap for Field Term Plug.	10	100

Contact customer service for part number information for RJ45 jack modules with 45 degree angled termination caps, additional colours and bulk packs.

Enterprise

Patch Panels, Kits and Accessories



CPPL24WBLY



CPPLA24WBLY



CPP48HDWBLY



CPPA48HDWBLY



SRB19BLY

Part Number	Description	Std. Pkg. Qty.	Std. Ctn. Qty.
Modular			
CPPL24WBLY	24-port patch panel with labels, with six CFFPL4 faceplates.	1	10
CPPLA24WBLY	24-port angled patch panel with labels, with six CFFPL4 faceplates.	1	10
CPPL48WBLY	48-port angled patch panel with labels, with twelve CFFPL4 faceplates.	1	10
CPPLA48WBLY	48-port patch panel with labels, with twelve CFFPL4 faceplates.	1	10
CPP48HDWBLY	48-port high-density patch panel, with rear-mounted faceplates.	1	10
CPPA48HDWBLY	48-port angled high-density patch panel, with rear-mounted faceplates.	1	10
CP24BLY	24-port all-metal shielded patch panel.	1	10
CPA24BLY	24-port angled all-metal shielded patch panel.	1	10
Strain Relief			
SRB19BLY	Strain relief bar.	1	10

Field Term RJ45 Plug



FP6X88MTG



FPUD6X88MTG

Part Number	Description	Std. Pkg. Qty.	Std. Ctn. Qty.
Straight Cable Entry			
FP6X88MTG	Category 6A UTP field term RJ45 plug.	1	50
FP6X88MTG-X	Category 6A UTP field term RJ45 plug, package of ten.	10	100
Angled Cable Entry			
FPUD6X88MTG	Category 6A UTP angled field term RJ45 plug.	1	50
FPUD6X88MTG-X	Category 6A UTP angled field term RJ45 plug, package of ten.	10	100
Straight Cable Entry – Shielded			
FPS6X88MTG	Category 6A shielded field term RJ45 plug.	1	50
FPS6X88MTG-X	Category 6A shielded field term RJ45 plug, package of ten.	10	100
Test Cord			
FP6X88TC	Field term RJ45 plug test cord, Red, 1 metre.	1	1

Enterprise RJ45 Patch Cords



UTP6ASD*

Part Number	Description	Std. Pkg. Qty.	Std. Ctn. Qty.
Category 6A			
UTP6ASD1M**	Category 6A 26 AWG patch cord, CM, 1m.	1	10
UTP6ASD2M**	Category 6A 26 AWG patch cord, CM, 2m.	1	10
UTP6ASD3M**	Category 6A 26 AWG patch cord, CM, 3m.	1	10
UTP6ASD5M**	Category 6A 26 AWG patch cord, CM, 5m.	1	10

**Denotes jack colour.

BU = Blue, RD = Red, GR = Green, YL = Yellow



UTP28X***

Part Number	Description	Std. Pkg. Qty.	Std. Ctn. Qty.
Category 6A 28 AWG			
UTP28X1M**	Category 6A 28 AWG patch cord, CM/LSZH, 1m.	1	10
UTP28X2M**	Category 6A 28 AWG patch cord, CM/LSZH, 2m.	1	10
UTP28X3M**	Category 6A 28 AWG patch cord, CM/LSZH, 3m.	1	10

**Denotes jack colour.

BU = Blue, RD = Red, GR = Green, YL = Yellow



STP28X*

Category 6A 28 AWG Shielded			
STP28X0.2M**	Category 6A 28 AWG, F/UTP patch cord, CM/LSZH, 200mm.	1	10
STP28X1M**	Category 6A 28 AWG, F/UTP patch cord, CM/LSZH, 1m.	1	10
STP28X2M**	Category 6A 28 AWG, F/UTP patch cord, CM/LSZH, 2m.	1	10
STP28X3M**	Category 6A 28 AWG, F/UTP patch cord, CM/LSZH, 3m.	1	10

**Denotes jack colour.

BU = Blue, RD = Red, GR = Green, YL = Yellow



UTPSP*

Category 6			
UTPSP1M**Y	Category 6 UTP patch cord, CM, 1m.	1	10
UTPSP2M**Y	Category 6 UTP patch cord, CM, 2m.	1	10
UTPSP3M**Y	Category 6 UTP patch cord, CM, 3m.	1	10
UTPSP5M**Y	Category 6 UTP patch cord, CM, 5m.	1	10

**Denotes jack colour.

BU = Blue, RD = Red, GR = Green, YL = Yellow



UTP28SP*

Category 6 28 AWG			
UTP28SP8IN**	Category 6 UTP 28 AWG patch cord, CM/LSZH, 200mm.	1	10
UTP28SP1M**	Category 6 UTP 28 AWG patch cord, CM/LSZH, 1m.	1	10
UTP28SP2M**	Category 6 UTP 28 AWG patch cord, CM/LSZH, 2m.	1	10
UTP28SP3M**	Category 6 UTP 28 AWG patch cord, CM/LSZH, 3m.	1	10

**Denotes jack colour.

BU = Blue, RD = Red, GR = Green, YL = Yellow

Contact Customer Service for other colours and lengths.

**Enterprise
Faceplate**



CFPE2WHY



CFP86S2WHY

Part Number	Description	Std. Pkg. Qty.	Std. Ctn. Qty.
CFPE1WHY	1-port executive vertical faceplate with labels, White.	1	10
CFPE2WHY	2-port executive vertical faceplate with labels, White.	1	10
CFPE4WHY	4-port executive vertical faceplate with labels, White.	1	10
CFP86S2WHY	2-port 86x86 sloped faceplate, White.	1	10
CFP86S4WHY	4-port 86x86 sloped faceplate, White.	1	10
CFPUKS2SWHY	2-port 86x86 sloped shuttered faceplate, White.	1	10

Blank Modules



CMBIW-X

Part Number	Description	Std. Pkg. Qty.	Std. Ctn. Qty.
CMBBL-X	Mini-Com™ 1-port blank module, Black.	10	50
CMBWH-X	Mini-Com™ 1-port blank module, White.	10	50

Contact Panduit Customer Service for other colours.

Fibre Optic Cable – Indoor



Part Number	Description	UOM	MOQ
FLDLZ06Y	6-fibre, OM4, LSZH, indoor distribution.	Metre	1000
FLDLZ12Y	12-fibre, OM4, LSZH, indoor distribution.	Metre	1000
FLDLX06Y	6-fibre, OM3, LSZH, indoor distribution.	Metre	1000
FLDLX12Y	12-fibre, OM3, LSZH, indoor distribution.	Metre	1000

Fibre Optic Cable – Indoor/Outdoor



Part Number	Description	UOM	MOQ
FLKLZ06	6-fibre, OM4, LSZH, tight buffered.	Metre	1000
FLKLZ12	12-fibre, OM4, LSZH, tight buffered.	Metre	1000
FLKLZ24	24-fibre, OM4, LSZH, tight buffered.	Metre	1000
FLKLX06	6-fibre, OM3, LSZH, tight buffered.	Metre	1000
FLKLX12	12-fibre, OM3, LSZH, tight buffered.	Metre	1000
FLKLX24	24-fibre, OM3, LSZH, tight buffered.	Metre	1000
FLKL906	6-fibre, OS2, LSZH, tight buffered.	Metre	1000
FLKL912	12-fibre, OS2, LSZH, tight buffered.	Metre	1000
FLKL924	24-fibre, OS2, LSZH, tight buffered.	Metre	1000

Fibre Optic Cable – Outdoor



Part Number	Description	UOM	MOQ
FLWNX06	6-fibre, OM3, loose tube, armoured outside plant.	Metre	1000
FLWNX12	12-fibre, OM3, loose tube, armoured outside plant.	Metre	1000
FLWN906	6-fibre, OS2, loose tube, armoured outside plant.	Metre	1000
FLWN912	12-fibre, OS2, loose tube, armoured outside plant.	Metre	1000

Enterprise

Fibre Patch Cords



NKFPX2ELLLSM001



NKFPX23LSSSM001

Part Number	Description	Std. Pkg. Qty.	Std. Ctn. Qty.
Fibre Patch Cords			
NKFPX2ELLLSM001	LC OM3, 1.6mm LSZH jacket duplex patch cord, 1m.	1	10
NKFPX2ELLLSM002	LC OM3, 1.6mm LSZH jacket duplex patch cord, 2m.	1	10
NKFPX2ELLLSM003	LC OM3, 1.6mm LSZH jacket duplex patch cord, 3m.	1	10
NKFPX2ELLLSM005	LC OM3, 1.6mm LSZH jacket duplex patch cord, 5m.	1	10
NKFP92ELLLSM001	LC OS2, 1.6mm LSZH jacket duplex patch cord, 1m.	1	10
NKFP92ELLLSM002	LC OS2, 1.6mm LSZH jacket duplex patch cord, 2m.	1	10
NKFP92ELLLSM003	LC OS2, 1.6mm LSZH jacket duplex patch cord, 3m.	1	10
NKFP92ELLLSM005	LC OS2, 1.6mm LSZH jacket duplex patch cord, 5m.	1	10
NKFPX23LSSSM001	SC OM3, 3mm LSZH jacket duplex patch cord, 1m.	1	10
NKFPX23LSSSM002	SC OM3, 3mm LSZH jacket duplex patch cord, 2m.	1	10
NKFPX23LSSSM003	SC OM3, 3mm LSZH jacket duplex patch cord, 3m.	1	10
NKFPX23LSSSM005	SC OM3, 3mm LSZH jacket duplex patch cord, 5m.	1	10
NKFP923LSSSM001	SC OS2, 3mm LSZH jacket duplex patch cord, 1m.	1	10
NKFP923LSSSM002	SC OS2, 3mm LSZH jacket duplex patch cord, 2m.	1	10
NKFP923LSSSM003	SC OS2, 3mm LSZH jacket duplex patch cord, 3m.	1	10
NKFP923LSSSM005	SC OS2, 3mm LSZH jacket duplex patch cord, 5m.	1	10

Contact Panduit Customer Service for other lengths.

Fibre Enclosures



FMT1



FMD1



FOSMF

Part Number	Description	Std. Pkg. Qty.	Std. Ctn. Qty.
FMT1	Rack mount fibre tray, 1 RU. Use with 24-port modular patch panel and Mini-Com™ Adapter Modules OR CFAPPBL1 patch panel and fibre adapter panels.	1	1
FMTJW24	Rack-mount fibre tray accepts four fibre adapter panels. Includes CFAPPBL1.	1	1
CFAPPBL1	Flat fibre patch panel. Holds up to four fibre adapter panels.	1	1
FMD1	Drawer enclosure holds up to four fibre adapter panels.	1	1
FOSMF	Fibre optic splice module, 24 fusion, for rack-mount enclosure.	1	1
FSC24	Fibre splice chip accommodates and protects up to 24 fusion splices, suits wall-mount or rack-mount enclosure.	1	1
FOSP61-C	60mm splice protector sleeve.	100	100

Enterprise

Fibre Adapter Modules and Panels



CMDAQSCZBL



FAP6WAQDSCZ

Part Number	Description	Std. Pkg. Qty.	Std. Ctn. Qty.
Fibre Adapter Modules			
CMDAQSCZBL	SC duplex (Aqua) adapter (Black) Mini-Com™ Module Assembly, zirconia.	1	10
CMDBUSCZBU	SC duplex (Blue) adapter (Blue) Mini-Com™ Module Assembly, zirconia.	1	10
CMDSAQLCZAQ	Duplex LC Sr./Sr. (Aqua) adapter (Aqua) Mini-Com™ Module Assembly, zirconia.	1	10
CMDSL CZBU	Duplex LC Sr./Sr. (Blue) adapter (Blue) Mini-Com™ Module Assembly, zirconia.	1	10
Fibre Adapter Panels			
FAP6WAQDSCZ	Fibre adapter panel with six SC duplex (Aqua) adapters, zirconia.	1	10
FAP6WBUDSCZ	Fibre adapter panel with six SC duplex (Blue) adapters, zirconia.	1	10
FAP6WAQDLCZ	Fibre adapter panel with six LC duplex (Aqua) adapters, zirconia.	1	10
FAP6WBUDLCZ	Fibre adapter panel with six LC duplex (Blue) adapters, zirconia.	1	10
FAP12WBUDLCZ	Fibre adapter panel with twelve LC duplex (Blue) adapters, zirconia.	1	10

Fibre Pigtail Sets



NKFPX1BN3NNM001



NKFPX1BN1NNM001

Part Number	Description	Std. Pkg. Qty.	Std. Ctn. Qty.
NKFPX1BN3NNM001	OM3 1-fibre, 900µm, buffered, SC to pigtail, 1m.	1	10
NKFP91BN3NNM001	OS2 1-fibre, 900µm buffered, SC to pigtail, 1m.	1	10
NKFPX1BN1NNM001	OM3 1-fibre, 900µm, buffered, LC to pigtail, 1m.	1	10
NKFP91BN1NNM001	OS2 1-fibre, 900µm, LC to pigtail, 1m.	1	10
NKFPX1BN1NKM001	OM3 1-fibre, 900µm, buffered, LC to pigtail, 1m, (colour coded set of 12).	1	25
NKFP91BN1NKM001	OS2 1-fibre, 900µm, buffered, LC to pigtail, 1m, (colour coded set of 12).	1	25

Cabinets*



DA8212BF

Part Number	Description	Std. Pkg. Qty.	Std. Ctn. Qty.
DA8212BF	42 RU 800mm wide x 1000mm deep, black assembled cabinet with perforated front and rear doors, side panels, casters, PDU brackets and cable management fingers.	1	1
DA6212B	42 RU 600mm wide x 1000mm deep, black assembled cabinet with perforated front and rear doors, side panels, casters and PDU brackets.	1	1
PZWMC12W	12 RU 635mm wide, 635mm deep, perforated doors	1	1

*Cabinets are also available 1200mm deep.

Enterprise

Racks, Shelves and Accessories



R4PCN



R2P

Part Number	Description	Std. Pkg. Qty.	Std. Ctn. Qty.
Racks			
R2P	2 post rack, 45 RU with threaded rails.	1	1
R4PCN	4 post rack, 45 RU with cage nut rails, 760mm deep.	1	1
Shelves			
SRM19FM1	Front mount shelf, 1 RU, 480mm deep.	1	1
RSHLF	Front and rear mount shelf, 1 RU, 760mm deep.	1	1
Rack Accessories			
S1224-C	#12-24 screws.	100	1000
CNWS1224-C	#12-24 cage nut with screws.	100	1000
CNWSM6-C	M6 cage nut with screws.	100	1000
R2PPDUB	PDU mounting kit, suits 2 post rack.	1	1
CVPDUB	PDU mounting kit, suits 4 post rack.	1	1
Grounding			
RGCBNJ660P22	Common bonding jumper and HTAP. HTCT2-2-1.	1	10
RGCBNJ660PY	Common bonding jumper and HTAP. HTCT250-2-1.	1	10
RGS134-1Y	Grounding strip for threaded rails.	1	10
RGS134B-1	Grounding strip for caged nut rails.	1	10
RGESDWS	ESD wrist strap with 6' coil cord, banana plug.	1	10
RGESD2-1	ESD port for threaded rail.	1	10
RGESD2B-1	ESD port for caged nut rail.	1	10
RGRB19U	Grounding bus bar for threaded rails.	1	10
RGRB19CN	Grounding bus bar for caged nut rails.	1	10
CNBK	Green bonding #12-24 cage nuts and bonding screws (package of 50).	1	10
RGTBSG-C	Green thread-forming bonding screw, #12-24 x 1/2".	100	1000

Cable Managers



NMF4



WMPSE



PR2VD12

Part Number	Description	Std. Pkg. Qty.	Std. Ctn. Qty.
NMF2	NetManager™ Horizontal Cable Manager, high capacity, front only, 2 RU.	1	1
NMF4	NetManager™ Horizontal Cable Manager, high capacity, front only, 4 RU.	1	1
WMPSE	PatchLink™ Horizontal Cable Manager, front and rear, 1 RU.	1	1
WMP1E	PatchLink™ Horizontal Cable Manager, front and rear, 2 RU.	1	1
WMPFSE	PatchLink™ Horizontal Cable Manager, front only, 1 RU.	1	1
WMPF1E	PatchLink™ Horizontal Cable Manager, front only, 2 RU.	1	1

Part Number	Description	Std. Pkg. Qty.	Std. Ctn. Qty.
Vertical Managers			
PR2VD06	PatchRunner™ 2 Vertical Cable Manager, front and rear, 45 RU, 6"W x 20.7"D, includes two metal dual-hinged doors.	1	—
PR2VD08	PatchRunner™ 2 Vertical Cable Manager, front and rear, 45 RU, 8"W x 20.7"D, includes two metal dual-hinged doors.	1	—
PR2VD12	PatchRunner™ 2 Vertical Cable Manager, front and rear, 45 RU, 12"W x 20.7"D, includes two metal dual-hinged doors.	1	—

PatchRunner™ 2 Vertical Cable Manager also available in White colour.

Enterprise

Cable Manager Capacity Chart

Part Number	Description	Front 30% fill				Rear 30% fill			
		Cat. 6A (28AWG)	Cat. 6A-SD (26AWG)	Cat. 6 (28AWG)	Cat. 6 (24AWG)	Cat. 6A (28AWG)	Cat. 6A-SD (26AWG)	Cat. 6 (28AWG)	Cat. 6 (24AWG)
NMF4	Horizontal cable manager high capacity front only, 4 RU.	271	166	414	166	—	—	—	—
WMPSE	PatchLink™ Horizontal Cable Manager, front and rear, 1 RU.	39	23	59	23	70	43	107	43
WMP1E	PatchLink™ Horizontal Cable Manager, front and rear, 2 RU.	84	52	129	52	118	72	180	72
WMPFSE	PatchLink™ Horizontal Cable Manager, front only, 1 RU.	39	23	59	23	—	—	—	—
WMPF1E	PatchLink™ Horizontal Cable Manager, front only, 2 RU.	84	52	129	52	—	—	—	—
PR2VD06	PatchRunner™ Dual-Sided Vertical Cable Manager, 150mm wide.	503	298	769	308	304	180	465	186
PR2VD08	PatchRunner™ Dual-Sided Vertical Cable Manager, 200mm wide.	710	421	1087	436	443	263	678	271
PR2VD12	PatchRunner™ Dual-Sided Vertical Cable Manager, 300mm wide.	1125	668	1721	690	721	428	1103	442

Blanking Panels



Part Number	Description	Std. Pkg. Qty.	Std. Ctn. Qty.
TLBP1S-V	Tool-less blanking panel, 1 RU, suit cage nut holes.	5	50
TLBP2S-V	Tool-less blanking panel, 2 RU, suit cage nut holes.	5	50
CPAF1BLY	Blanking panel, angled, 1 RU.	1	10
CPAF2BLY	Blanking panel, angled, 2 RU.	1	10
FLBSIM-51	Full-length blanking shade, 4 – 51 RU.	5	50
BR1B	Blanking panel, brush seal front to back passthrough, 1 RU.	1	10
CPATCBL	Angled patch panel, transition cover.	1	—

Enterprise

Labeling



LS8EQ-KIT

Part Number	Description	Std. Pkg. Qty.	Std. Ctn. Qty.
LS8EQ-KIT	LS8EQ hand-held printer with QWERTY keypad.	1	1
LS8E-ACU	100 – 240 VAC power adapter with UK style plug.	1	1
C252X030FJC	Modular patch panel (CP) adhesive label cassette.	1	10
C261X035Y1C	Modular patch panel (CPPL) label cassette.	1	10
S100X150VAC	Cable self-laminating label cassette.	1	10
R100X150V1C	Turn-Tell™ Patch Cord Label Cassette.	1	10
F100X150AJC	Flag label cassette, polyester.	1	10
T100X000VPC-BK	Vinyl tape label cassette, 25mm wide.	1	10

Tools



EGJT-1



TGJT



TGSJT



CBOT24K

Part Number	Description	Std. Pkg. Qty.	Std. Ctn. Qty.
EGJT-1	TG jack and Field term plug termination tool, Green colour.	1	—
TGJT	TG jack termination tool, for high-volume installations.	1	—
TGSJT	Angled TG-style jack termination tool.	1	1
EGPT	Field term plug 45 degree cap termination tool, Violet colour.	1	1
CJAST	Copper cable jacket stripper.	1	1
CWST	Copper wire snips.	1	1
PDT110	110 punchdown tool.	1	1
CBOT24K	Cable bundle organising tool.	1	10

Fibre Optic Termination Tools



FOCTT2-BKIT



FOCTT2-PKIT

Part Number	Description	Std. Pkg. Qty.	Std. Ctn. Qty.
FOCTT2-KIT	OptiCam™ 2 Tool Kit includes batteries, case, launch cords and one cradle for each OptiCam™ LC, SC2 and ST2 Connector.	1	1
FOCTT2-BKIT	OptiCam™ 2 Tool Kit includes batteries, case, launch cords and one cradle for each OptiCam™ LC, SC2 and ST2 Connector, Fitel cleaver, installation tools, cleaning and consumables.	1	1
FOCTT2-PKIT	OptiCam™ 2 Tool Kit includes batteries, case, launch cords and one cradle for each OptiCam™ LC, SC2 and ST2 Connector, Sumitomo Cleaver, installation tools, cleaning and consumables.	1	1

Data Centre

OM4 12-Fibre MPO-LC Cassette



FQZO-12-10A*



FHCZO-12-10A*



FC2ZO-12-10A*



FC2ZO-24-10A*

Part Number	Part Description	Std. Pkg. Qty.	Std. Ctn. Qty.
QuickNet™ SFQ Cassettes			
FQZO-12-10AS	12-fibre QuickNet™ SFQ Cassette, six LC duplex adapters to MTP, OM4, Method A.	1	10
FQZO-12-10AF	12-fibre QuickNet™ SFQ Cassette, six LC duplex adapters to MTP, OM4, modified Method A, pair flipped.	1	10
HD Flex™ Cassettes			
FHCZO-12-10AS	12-fibre HD Flex™ Cassette, six LC duplex adapters to MTP, OM4, Method A.	1	10
FHCZO-12-10AF	12-fibre HD Flex™ Cassette, six LC duplex adapters to MTP, OM4, modified Method A, pair flipped.	1	10
QuickNet™ FC2 Cassettes			
FC2ZO-12-10AS	12-fibre QuickNet™ FC2 Cassette, six LC duplex adapters to MTP, OM4, Method A.	1	10
FC2ZO-12-10AF	12-fibre QuickNet™ FC2 Cassette, six LC duplex adapters to MTP, OM4, modified Method A, pair flipped.	1	10
FC2ZO-24-10AS	24-fibre QuickNet™ FC2 Cassette, 12 LC duplex adapters to (2) MTP, OM4, Method A.	1	10
FC2ZO-24-10AF	24-fibre QuickNet™ FC2 Cassette, 12 LC duplex adapters to (2) MTP, OM4, modified Method A, pair flipped.	1	10

Optimised Insertion loss (IL) 0.5dB per channel.
Also available in standard insertion loss (IL) 0.75 db max. per channel.

OM4 12-Fibre MPO Interconnect



FZTRL7N7NANM0**

Part Number	Part Description	Std. Pkg. Qty.	Std. Ctn. Qty.
FZTRL7N7NANM002	OM4 12-fibre, PanMPO™ Interconnect Cable Assembly, LSZH, PanMPO™ Female to PanMPO™ Female, Aqua, 2 metre.	1	10
FZTRL7N7NANM003	OM4 12-fibre, PanMPO™ Interconnect Cable Assembly, LSZH, PanMPO™ Female to PanMPO™ Female, Aqua, 3 metre.	1	10
FZTRL7N7NANM005	OM4 12-fibre, PanMPO™ Interconnect Cable Assembly, LSZH, PanMPO™ Female to PanMPO™ Female, Aqua, 5 metre.	1	10
FZTRL7N7NANM010	OM4 12-fibre, PanMPO™ Interconnect Cable Assembly, LSZH, PanMPO™ Female to PanMPO™ Female, Aqua, 10 metre.	1	10
FZTRL7N7NANM015	OM4 12-fibre, PanMPO™ Interconnect Cable Assembly, LSZH, PanMPO™ Female to PanMPO™ Female, Aqua, 15 metre.	1	10
FZTRL7N7NANM020	OM4 12-fibre, PanMPO™ Interconnect Cable Assembly, LSZH, PanMPO™ Female to PanMPO™ Female, Aqua, 20 metre.	1	10
FZTRL7N7NANM025	OM4 12-fibre, PanMPO™ Interconnect Cable Assembly, LSZH, PanMPO™ Female to PanMPO™ Female, Aqua, 25 metre.	1	10
FZTRL7N7NANM030	OM4 12-fibre, PanMPO™ Interconnect Cable Assembly, LSZH, PanMPO™ Female to PanMPO™ Female, Aqua, 30 metre.	1	10

Data Centre

PanMPO™ Fibre Connector Change Polarity



Key-Up

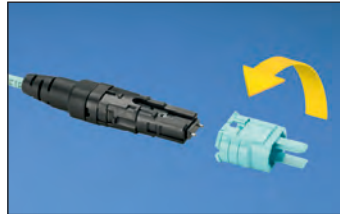

Remove Outer Housing,
Flip and Reinstall



Key-Down

Change Gender

CapEX Cost Savings
One fiber cable assembly
with the PanMPO™
Connector replaces six
standard assemblies.

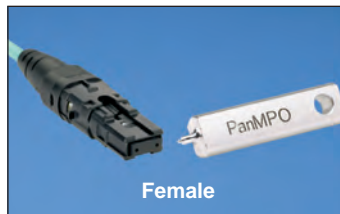

Remove Outer Housing



Using Pin Extend/Retract
Tool Pull Pins Forward

10G to 40G Migration

PanMPO™ Connector makes 10G to 40G migration easy.
Discover how easy here: www.panduit.com/panmpo

10G Method A with PanMPO™



40G Method B with PanMPO™

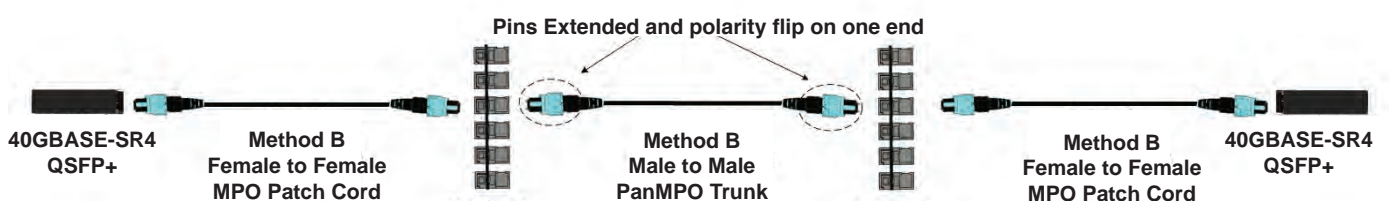

Panduit recommends the use of Method B polarity for 40G multimode parallel fiber solutions. Method B (Key Up to Key Up array connectivity) is widely used throughout the industry and is discussed in TIA-568-C.1. Method B array connectivity allows for the same equipment patch cords to be used whether the channel is comprised of the LC based 10GBASE-SR technology using array solutions in the horizontal cabling infrastructure or the MPO based 40GBASE-SR4 technology using array solutions throughout the infrastructure.

To assist with array polarity and gender, Panduit is offering the PanMPO™ which is a gender/polarity changeable MPO connector. PanMPO™ will allow for either male/female gender or key up/key down or key up/key up MPO trunk configurations.

Data Centre

OS2 12-Fibre MPO-LC Cassette



FQ9N-12-10A*



FHC9N-12-10A*



FC29N-12-10A*



FC29N-24-10A*

Part Number	Part Description	Std. Pkg. Qty.	Std. Ctn. Qty.
QuickNet™ SFQ Cassettes			
FQ9N-12-10AS	12-fibre QuickNet™ SFQ Cassette, six LC duplex adapters to MTP, OS2, Method A.	1	10
FQ9N-12-10AF	12-fibre QuickNet™ SFQ Cassette, six LC duplex adapters to MTP, OS2, modified Method A, pair flipped.	1	10
HD Flex™ Cassettes			
FHC9N-12-10AS	12-fibre HD Flex™ Cassette, six LC duplex adapters to MTP, OS2, Method A.	1	10
FHC9N-12-10AF	12-fibre HD Flex™ Cassette, six LC duplex adapters to MTP, OS2, modified Method A, pair flipped.	1	10
QuickNet™ FC2 Cassettes			
FC29N-12-10AS	12-fibre QuickNet™ FC2 Cassette, six LC duplex adapters to MTP, OS2, Method A.	1	10
FC29N-12-10AF	12-fibre QuickNet™ FC2 Cassette, six LC duplex adapters to MTP, OS2, modified Method A, pair flipped.	1	10
FC29N-24-10AS	24-fibre QuickNet™ FC2 Cassette, 12 LC duplex adapters to (2) MTP, OS2, Method A.	1	10
FC29N-24-10AF	24-fibre QuickNet™ FC2 Cassette, 12 LC duplex adapters to (2) MTP, OS2, modified Method A, pair flipped.	1	10

Standard insertion loss (IL) 0.75 db max. per channel.

OS2 12-Fibre MPO Interconnect, Method A



F9TRL5N5NANM0**

Part Number	Part Description	Std. Pkg. Qty.	Std. Ctn. Qty.
F9TRL5N5NANM010	OS2 12-fibre, interconnect cable assembly, LSZH, MPO female to MPO female, Method A, Yellow, 10 metre.	1	10
F9TRL5N5NANM015	OS2 12-fibre, interconnect cable assembly, LSZH, MPO female to MPO female, Method A, Yellow, 15 metre.	1	10
F9TRL5N5NANM020	OS2 12-fibre, interconnect cable assembly, LSZH, MPO female to MPO female, Method A, Yellow, 20 metre.	1	10
F9TRL5N5NANM025	OS2 12-fibre, interconnect cable assembly, LSZH, MPO female to MPO female, Method A, Yellow, 25 metre.	1	10
F9TRL5N5NANM030	OS2 12-fibre, interconnect cable assembly, LSZH, MPO female to MPO female, Method A, Yellow, 30 metre.	1	10

Data Centre

QuickNet™ Cassette Patch Panels



QAPP24BL



QPP48HDBL



CFAPPBL1

Part Number	Part Description	Std. Pkg. Qty.	Std. Ctn. Qty.
QAPP24BL	24-port, angled patch panel which accepts QuickNet™ Cassettes and Patch Panel Adapters.	1	10
QPP24BL	24-port, patch panel which accepts QuickNet™ Cassettes and Patch Panel Adapters.	1	10
QAPP48HDBL	48 port, angled high density patch panel which accepts QuickNet™ Cassettes and Patch Panel Adapters.	1	10
QPP48HDBL	48 port, angled high density patch panel which accepts QuickNet™ Cassettes and Patch Panel Adapters.	1	10
QPPABL	QuickNet™ Patch Panel Adapter which accepts Mini-Com™ Modules for UTP, fiber optic, and audio/visual applications.	1	10
QPPBBL	QuickNet™ Patch Panel Blank.	1	10
QPPLC24	QuickNet™ Patch Panel Label/Label Cover Kit, four labels and covers.	1	10
CFAPPBL1	Flat fibre patch panel which accepts four QuickNet™ FC2 Cassettes.	1	10
CFAPPBL1A	Angled fibre patch panel which accepts four QuickNet™ FC2 Cassettes.	1	10
FAPB	Fibre patch panel blank.	1	10

QuickNet™ Accessories



FPFPC1



FQCRCM

Part Number	Part Description	Std. Pkg. Qty.	Std. Ctn. Qty.
FPFPC1	1 RU fibre patch field protection cover. Includes a labeling card and D-rings. Not compatible with angled patch panels.	1	10
FQCRCM	QuickNet™ Cassette Patch Panel Rear Cable Manager, manages up to one meter of slack for sixteen MTP interconnect cables.	1	10

HD Flex™ Fibre Cabling System Panels



FLEX1UPN06

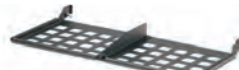

FLEX-PLATE1U



FLEX-PLATE4U

Part Number	Part Description	Std. Pkg. Qty.	Std. Ctn. Qty.
FLEX1UPN06	HD Flex™ Fibre Panel, 1RU, 12 cassette capacity.	1	—
FLEX2UPN06	HD Flex™ Fibre Panel, 2RU, 24 cassette capacity.	1	—
FLEX4UPN06	HD Flex™ Fibre Panel, 4RU, 48 cassette capacity.	1	—
FLEX-PLATE1U	HD Flex™ Fibre Enclosure trunk slack plate, 1RU.	1	1
FLEX-PLATE4U	HD Flex™ Fibre Enclosure trunk slack plate, 4RU.	1	1

HD Flex™ Cable Managers



FLEX-FCM1UA



FLEX-RCM1U

Part Number	Part Description	Std. Pkg. Qty.	Std. Ctn. Qty.
FLEX-FCM1UA	HD Flex™ Front Cable Manager, 1RU, Black.	1	—
FLEX-FCM2UA	HD Flex™ Front Cable Manager, 2RU, Black.	1	—
FLEX-FCM4UA	HD Flex™ Front Cable Manager, 4RU, Black.	1	—
FLEX-RCM1U	HD Flex™ Rear Cable Manager, 1RU, Black.	1	—
FLEX-RCM2U	HD Flex™ Rear Cable Manager, 2RU, Black.	1	—
FLEX-RCM4U	HD Flex™ Rear Cable Manager, 4RU, Black.	1	—

Data Centre

OM4 24-FibreMPO Trunk

24 fibre MPO trunks are typically built to order, ask your Panduit representative about our **10 business day** delivery program.

QuickNet™ Small Diameter Trunk Cable Assemblies

Steps to Select:

- 1 Select Cable Options
- 2 Select Ends 1 and 2
- 3 Select Construction/Performance
- 4 Select Length

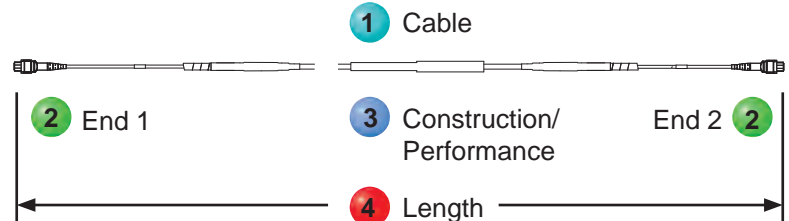

Multimode Trunks

Example: FXUYL7E7EAAF015 – OM3 24-Fiber Indoor Small Diameter Trunk LSZH (Low Smoke Zero Halogen), Female PanMPO™ Connector to Female PanMPO™ Connector, Method A, Std. IL, Pulling Eye end A – 15 Feet.

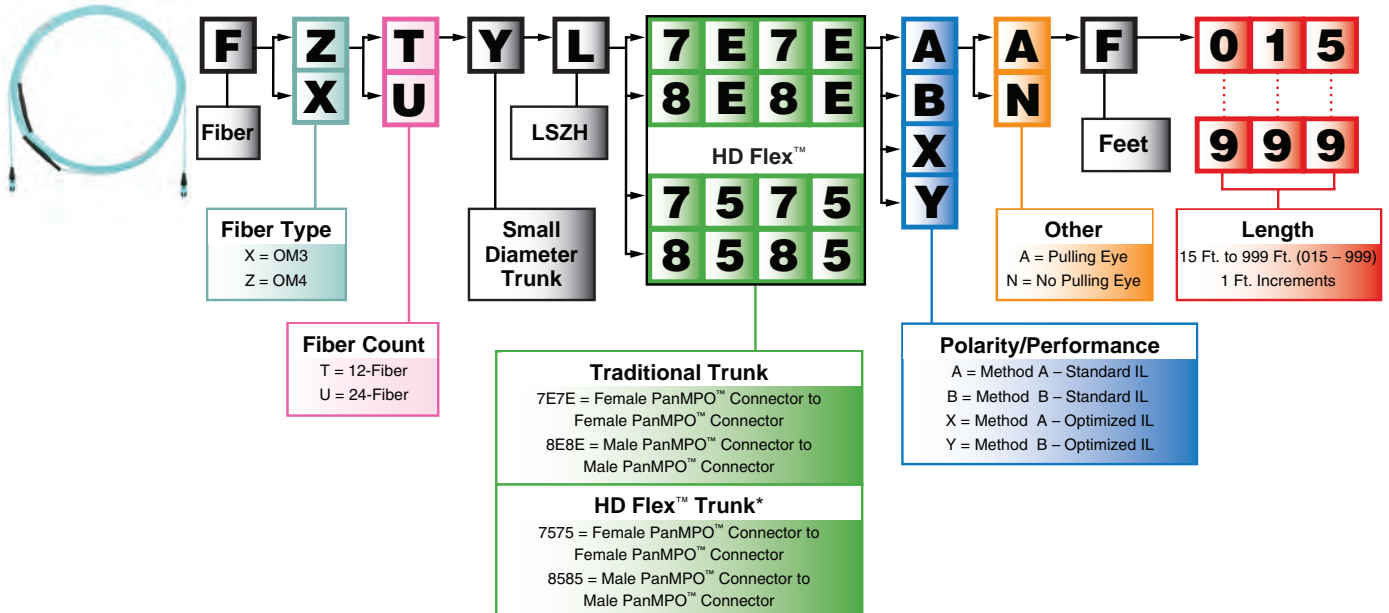

Singlemode Trunks

Example: F9TYL5E5EAAF015 – OS2 12 Fiber Small Diameter Indoor Trunk LSZH (Low Smoke Zero Halogen), MPO Female to MPO Female, Method A, Std. IL, Pulling Eye – 15 Feet.

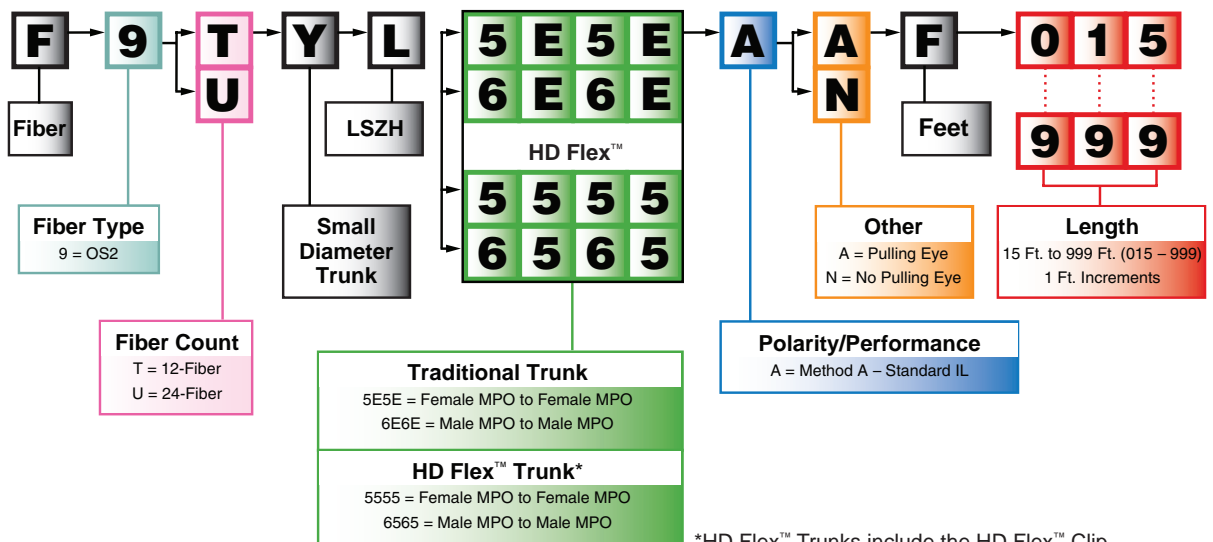

*HD Flex™ Trunks include the HD Flex™ Clip.

Data Centre

QuickNet™ Copper Category 6A Small Diameter

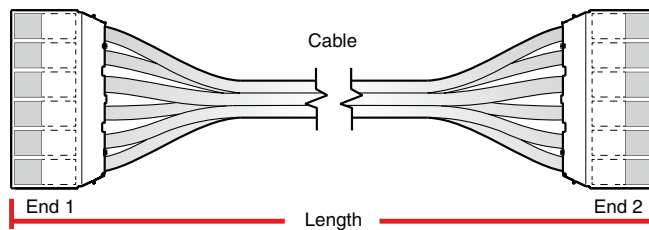

Ordering Information

Example:

Q	X	C	B	C	B	C	B	X	X	3	M	5
1	2	3	4	5	6	7	8	9	10	11	12	13

Part number QXCBCBCBX3M5 represents a 3.5 metre QuickNet™ Cable Assembly constructed of Blue, CM, Category 6A UTP copper cable with pre-terminated cassettes on each end that contain Blue TX6A™ 10Gig UTP Jack Modules.

1 – Q = QuickNet™

2 – Performance Level

- A = Category 6A (TX6A™ 10Gig) UTP
- C = Category 6 UTP
- X = Category 6A (TX6A-SD™ 10Gig) UTP SD MaTriX
- Z = Category 6A (TX6A™ 10Gig) UTP MaTriX

3 – Flame/Smoke Rating

- C = CM
- L = LSZH

4 – Cable Color

- B = Blue or W = White

5 – Termination End 1

- C = Cassette
- J = Jack modules
- K = Jack modules staggered right
- L = Jack modules staggered left

6 – Termination End 1 Jack Module Color*

- B = Blue
 - E = Electric Ivory
 - G = Green
 - H = Off White
 - I = International Gray
 - L = Black
 - O = Orange
 - R = Red
 - V = Violet
 - W = White
 - Y = Yellow
- (Shielded Jack Modules available in Black only)

7 – Termination End 2

- A = Plug pack (6-pack)
- C = Cassette
- P = Modular plugs
- K = Jack modules staggered right
- L = Jack modules staggered left
- Q = Modular plugs staggered right
- R = Recessed plug pack (6-pack)
- S = Modular plugs staggered left
- U = Unterminated
- O = Unterminated with cassette and jack modules for on-site termination

8 – Termination End 2 Color*

- B = Blue
 - E = Electric Ivory
 - G = Green
 - H = Off White
 - I = International Gray
 - L = Black
 - O = Orange
 - R = Red
 - V = Violet
 - W = White
 - Y = Yellow
- (Shielded Jack Modules available in Black only)

9 – Assembly Options

- P = Pulling eye
- X = No assembly options requested

10 – Custom Labeling**

- L = Custom label assembly
- C = Custom cable labels
- B = Custom assembly and cable labels
- X = No custom labels requested

11 – Assembly Length**

- 3 – 90 metre

12 – M = Metre Length

13 – Additional length (0.5m increments)

- 0 = No partial length
- 5 = 0.5m partial length

Data Centre

OM4 LC-LC Patch Cords



FZ2ELLNLNSNM001

Part Number	Part Description	Std. Pkg. Qty.	Std. Ctn. Qty.
FZ2ELLNLNSNM001	LC OM4, 1.6mm LSZH Aqua jacket duplex patch cord, 1m.	1	10
FZ2ELLNLNSNM002	LC OM4, 1.6mm LSZH Aqua jacket duplex patch cord, 2m.	1	10
FZ2ELLNLNSNM003	LC OM4, 1.6mm LSZH Aqua jacket duplex patch cord, 3m.	1	10
FZ2ELLNLNSNM005	LC OM4, 1.6mm LSZH Aqua jacket duplex patch cord, 5m.	1	10
FZ2ELLNLNSNM010	LC OM4, 1.6mm LSZH Aqua jacket duplex patch cord, 10m.	1	10
FZ2ELLNLNSNM015	LC OM4, 1.6mm LSZH Aqua jacket duplex patch cord, 15m.	1	10
FZ2ELLNLNSNM020	LC OM4, 1.6mm LSZH Aqua jacket duplex patch cord, 20m.	1	10

OS2 LC-LC Patch Cords



F92ELLNLNSNM001

Part Number	Part Description	Std. Pkg. Qty.	Std. Ctn. Qty.
F92ELLNLNSNM001	LC OS2, 1.6mm LSZH Yellow jacket duplex patch cord, 1m.	1	10
F92ELLNLNSNM002	LC OS2, 1.6mm LSZH Yellow jacket duplex patch cord, 2m.	1	10
F92ELLNLNSNM003	LC OS2, 1.6mm LSZH Yellow jacket duplex patch cord, 3m.	1	10
F92ELLNLNSNM005	LC OS2, 1.6mm LSZH Yellow jacket duplex patch cord, 5m.	1	10
F92ELLNLNSNM010	LC OS2, 1.6mm LSZH Yellow jacket duplex patch cord, 10m.	1	10
F92ELLNLNSNM015	LC OS2, 1.6mm LSZH Yellow jacket duplex patch cord, 15m.	1	10
F92ELLNLNSNM020	LC OS2, 1.6mm LSZH Yellow jacket duplex patch cord, 20m.	1	10

Category 6A Patch Cords



UTP6ASD*MBU

Part Number	Part Description	Std. Pkg. Qty.	Std. Ctn. Qty.
Category 6 Small Diameter			
UTP6ASD1MBU	Category 6A UTP patch cord, Blue, 1 metre.	1	10
UTP6ASD2MBU	Category 6A UTP patch cord, Blue, 2 metre.	1	10
UTP6ASD3MBU	Category 6A UTP patch cord, Blue, 3 metre.	1	10
UTP6ASD5MBU	Category 6A UTP patch cord, Blue, 5 metre.	1	10
UTP6ASD10MBU	Category 6A UTP patch cord, Blue, 10 metre.	1	10
UTP6ASD15MBU	Category 6A UTP patch cord, Blue, 15 metre.	1	10



UTP28X*MBU

Part Number	Part Description	Std. Pkg. Qty.	Std. Ctn. Qty.
Category 6A 28 AWG			
UTP28X1MBU	Category 6A UTP 28 AWG patch cord, Blue, 1 metre.	1	10
UTP28X2MBU	Category 6A UTP 28 AWG patch cord, Blue, 2 metre.	1	10
UTP28X3MBU	Category 6A UTP 28 AWG patch cord, Blue, 3 metre.	1	10

Contact Customer Service for other colours and lengths.

Data Centre

10Gig SFP+ Direct Attach Passive Copper Cable Assemblies



PSF1PXA*MBL

Part Number	Description	Std. Pkg. Qty.	Std. Pkg. Qty.
PSF1PXA1.5MBL	SFP+ 10Gig Direct Attach Passive Copper Cable Assembly, 1.5m, Black.	1	10
PSF1PXA2MBL	SFP+ 10Gig Direct Attach Passive Copper Cable Assembly, 2m, Black.	1	10
PSF1PXA3MBL	SFP+ 10Gig Direct Attach Passive Copper Cable Assembly, 3m, Black.	1	10

*Direct Attach Passive Cable Assemblies shown in BL (Black). Other colours available: WH (White), BU (Blue), RD (Red), GR (Green), or OR (Orange). Available in 0.5m length increments from 0.5m to 7m.

Security Devices



PSL-LCAB-AQ



FLCCLIW-X



PSL-DCJB



PSL-DCPLRX

Part Number	Description	Std. Pkg. Qty.	Std. Ctn. Qty.
PSL-LCAB-AQ	LC duplex adapter blockout device, ten devices (Aqua) and one removal tool (Black).	1	20
PSL-LCAB-BU	LC duplex adapter blockout device, ten devices (Blue) and one removal tool (Black).	1	20
FLCCLIW-X	LC patch plug lock-in device, ten devices and one removal tool.	10	100
PSL-DCJB-BL	Jack module blockout device, ten block-outs (Black) and one removal tool (Black).	1	20
PSL-DCJB-BU	Jack module blockout device, ten block-outs (Blue) and one removal tool (Black).	1	20
PSL-DCJB	Jack module blockout device, ten block-outs (Red) and one removal tool (Black).	1	20
PSL-DCPLRX-BL	Recessed RJ45 plug lock-in device, ten devices (Black) and one installation/removal tool (Black).	1	20
PSL-DCPLRX-BU	Recessed RJ45 plug lock-in device, ten devices (Blue) and one installation/removal tool (Black).	1	20
PSL-DCPLRX	Recessed RJ45 plug lock-in device, ten devices (Red) and one installation/removal tool (Black).	1	20

Data Centre

Cabinets



D-Type Cabinets

Part Number	Description	Std. Pkg. Qty.	Std. Ctn. Qty.
Net-Verse™ Cabinets			
DA6212B	Net-Verse™ D-Type Cabinet Frame, 42 RU. Top panel with brush openings. Two sets cage nut equipment rails. Single hinge perforated front door. Split perforated rear doors. Horizontally split side panels (4). Two full length PDU brackets. Dimensions: 2045mm x 600mm x 1000mm. Colour: Black.	1	—
DA6222B	Net-Verse™ D-Type Cabinet Frame, 42 RU. Top panel with brush openings. Two sets cage nut equipment rails. Single hinge perforated front door. Split perforated rear doors. Horizontally split side panels (4). Two full length PDU brackets. Dimensions: 2045mm x 600mm x 1200mm. Colour: Black.	1	—
DA8212BF	Net-Verse™ D-Type Cabinet Frame, 42 RU. Top panel with brush openings. Two sets cage nut equipment rails. Single hinge perforated front door. Split perforated rear doors. Horizontally split side panels (4). Two full length PDU brackets. Includes cable management fingers. Dimensions: 2045mm x 800mm x 1000mm. Colour: Black.	1	—
DA8222BF	Net-Verse™ D-Type Cabinet Frame, 42 RU. Top panel with brush openings. Two sets cage nut equipment rails. Single hinge perforated front door. Split perforated rear doors. Horizontally split side panels (4). Two full length PDU brackets. Includes cable management fingers. Dimensions: 2045mm x 800mm x 1200mm. Colour: Black.	1	—



Net-Verse™ Cabinet Accessories			
D6VBPB	Vertical blanking panels, 42/45/48 RU 600mm cabinet, set of 2.	1	—
D8VBPB	Vertical blanking panels, 42/45/48 RU 800mm cabinet, set of 2	1	—
TLBP1S-V	Tool-less blanking panel, 1 rack unit, square hole.	1	—
FLBSIM-51	Blanking shade for 4 – 51 consecutive rack units on 19" std. rails, Black.	1	—
BR1B	Blanking panel, brush seal front to back passthrough, 1 RU.	1	—

Data Centre

Power Distribution Units (PDUs)

SmartZone™ G5 Basic Power Distribution Units (PDUs)



Part Number	Form Factor	Input Current Per Phase	Input Phase	Input Plug Type	Outlet Count	Outlet Type	Output Voltage
Basic Power Distribution Units (PDUs)							
P12B34M	1U	16	1	IEC60309	12	(12)C13	240
P22B39M	0U Full	16	1	IEC60309	22	(20)C13, (2)C19	240
P30B06M	0U Full	32	1	IEC60309	30	(24)C13, (6)C19	240

Ask your Panduit representative about monitored and switched PDU's and environmental monitoring options.

SmartZone™ G5 Power Cords



Part Number Qty. 1	Part Number Qty. 10	Description	Ratings	Cross Section Area	Jacket	Connector Angle	Length (ft.)	Colour
NPCA14	NPCA14X	IEC C14 to IEC C13	10A/250V	1.0mm ²	H05VV-F	Straight	6*	Black**
NPCB14	NPCB14X	IEC C20 to IEC C19	16A/250V	1.5mm ²	H05VV-F	Straight	6*	Black**

*Also available in 2, 3, 4, and 10 ft. lengths.

**Also available in Red, Blue, Yellow, and Grey.

Wyr-Grid™ Overhead Cable Tray Routing System



Part Number	Description	Std. Pkg. Qty.	Std. Ctn. Qty.
Wyr-Grid™ Pathway			
WG12BL10	12" wide x 10 ft. (3 metre) long pathway section used to carry cables horizontally throughout the system.	10	—
Wyr-Grid™ Sidewalls			
WGIBRC4BL	Wyr-Grid™ 4" (102mm) high Snap-On Intersection Bend Radius Control provides 3" (76mm) bend radius control.	1	—
WGSW4BL	Wyr-Grid™ 4" (102mm) high Snap-On Sidewalls.	1	40
Wyr-Grid™ Splice Connectors			
WGINTSPLBL	Intersection splice connector quickly joins Wyr-Grid™ Pathways at all intersections.	1	10
WGSPL1218BL	Straight splice connector quickly joins two 8" (203mm), 12" (305mm) or 18" (457mm) wide Wyr-Grid™ Pathways together.	1	10
Wyr-Grid™ Waterfalls			
WGBTMWFBLL	Bottom waterfall provides 1.38" (35mm) bend radius control for cables transitioning down into the racks or cabinets from within the Wyr-Grid™ Pathway.	1	10
WGSWF4BL	The side waterfall provides 3" (76mm) bend radius control for cables transitioning down into the racks or cabinets from the side of the Wyr-Grid™ Pathway.	1	5
Wyr-Grid™ Brackets			
WGTBS12BL	Bracket used to support 12" (305mm) wide Wyr-Grid™ Pathway from the ceiling using a pair of 1/2" or 12mm threaded rod drops.	1	5
WGWMTB12BL	Bracket used to support the end of the 12" (305mm) Wyr-Grid™ Pathway against the wall. Mounting hardware for attaching to wall not included.	1	5

Additional widths available, 8" (203mm), 18" (457mm), 24" (610mm), and 30" (762mm).

Contact Panduit Customer Service for additional information or, www.panduit.com.

For pathway, order number of feet required, in multiples of standard 10' length increments.

Data Centre

FiberRunner™ System



Part Number	Part Description	Std. Pkg. Qty.	Std. Ctn. Qty.
-------------	------------------	----------------	----------------

Channel 6x4 System

FR6X4YL6	6x4 FibreRunner™ Channel, 6 foot length.	6	36
FRBC6X4YL	6x4 FibreRunner™ Base Coupler.	1	5

Fittings 6x4 System

FRRA6X4YL	6x4 FibreRunner™ Right Angle.	1	5
FRT6X4YL	6x4 FibreRunner™ Tee.	1	5

Brackets 6x4 and 4x4 System

FR6TRBN12M	6x4 FibreRunner™ Threaded Rod Support Bracket, 12mm.	1	10
------------	--	---	----

Channel 4x4 System

FR4X4YL6	4x4 FibreRunner™ Channel, 6 foot length.	6	12
FRBC4X4YL	4x4 FibreRunner™ Base Coupler.	1	5

Fittings 4x4 System

FRRA4X4YL	4x4 FibreRunner™ Right Angle.	1	—
FRT4X4YL	4x4 FibreRunner™ Tee.	1	—

Spillovers

FRSPJ4X4YL	FibreRunner™ Spillover with 4x4 exit.	1	—
FRIDT4X4YL	FibreRunner™ Spillover adapter for 2 corrugated tube exits, requires 4x4 base coupler to attach to spillover.	1	5
FRBC4X4YL	4x4 FibreRunner™ Base Coupler.	1	5
FRSPJ2X2YL	FibreRunner™ Spillover with 2x2 exit.	1	—
FIDT2X2YL	One port spill out to corrugated tube, to suit FRSPJ2x2YL exit.	1	5
FBC2X2YL	2x2 base coupler required for attaching FIDT2x2YL to FRSPJ2x2YL.	1	5
CLT150F-X4	Corrugated tube, Yellow, 10 foot length.	1	—

Covers are available for channel and fittings and are sold separately. This is just part of the extensive range of fittings and mounting brackets available for the FiberRunner™ System. Please consult your panduit representative for advice or visit panduit.com.

Data Centre

Cable Ties and Bundling



Part Number	Description	Std. Pkg. Qty.	Std. Ctn. Qty.
HLM-15R0	Hook & loop roll, 4.6m L, 8.4mm W, Black.	1	10
HLS-75R0	Hook & loop roll, 22.9m L, 19mm W, Black.	1	10
HLS-15R0	Hook & loop roll, 4.6m L, 19mm W, Black.	1	10
HLT2I-X0	Hook & loop tie, loop style, 203mm L, 12.7mm W, Black.	10	100
TTR-35RX0	Hook & loop roll, 10 roll-pack, low profile, 10.7m L, 19mm W, Black.	1	10
TTR-75R0	Hook & loop roll, low profile, 22.8m L, 19mm W, Black.	1	10
ERT2M-C20	Elastomeric cable ties, Miniature cross section, 216mm L, tensile strength: 80, bundles up to 60mm, Black.	100	1000

Cable Accessories



Part Number	Description	Std. Pkg. Qty.	Std. Ctn. Qty.
ABMM-A-D	4-way adhesive backed cable tie mount, mounted with rubber adhesive tape. 19.1mm long x 19.1mm wide, White.	500	5000
ABM2S-A-D	4-way adhesive backed cable tie mount, mounted with rubber adhesive tape. 25.4mm long x 25.4mm wide, White.	500	5000
ABMT-A-C	Cable tie mount for use with HLT/HLS Tak-Ty™ Hook & Loop Cable Ties, mounted with a rubber adhesive tape. 28.5mm long x 28.5mm wide, Natural.	100	1000
ABMT-A-C20	Cable tie mount for use with HLT/HLS Tak-Ty™ Hook & Loop Cable Ties, mounted with a rubber adhesive tape. 28.5mm long x 28.5mm wide, Black.	100	1000
BEC38-A-L	Adhesive backed bevel entry clip, 9.7mm bundle, Natural.	50	500
ACC19-A-C	Adhesive backed cord clip, 4.8mm bundle, Natural.	100	1000
CLT150F-X4	Corrugated loom tubing slit wall measures 38.1mm x 3.0m, Yellow.	1	—
GEE99F-A-C	Slotted grommet edging with adhesive lined, 0.099" thickness, Natural.	1	—

Industrial Networks

IndustrialNet™ Copper Cable



ISX6004AIG-LD-S



IFRH6C04BL-UG

Part Number	Description	(MOQ)*	Min. Order Incrmt. (MOI)*	UOM
ISFCH6X04ATL-US	Category 6A, 4 pair, 24 AWG stranded, SF/UTP, CMR, Black, UV/Oil resistant.	20000	1000	Ft.
ISX6004AIG-LD-S	Category 6, 4 pair, 24 AWG stranded, S/FTP, CMR, International Grey.	1	1	Reel
ISFCH5C04ATL-XG	Category 5e, 4 pair, 24 AWG stranded, SF/FTP, CM, Teal.	20000	1000	Ft.
IFRH6C04BL-UGS	Category 6, 4-pair, 23 AWG solid, F/UTP, industrial 600V, (CMR), Black.	20000	1000	Ft.

*MOQ needs to be met prior to MOI. Contact Panduit Customer Service for additional information. Additional colours available. Contact Panduit Customer Service for additional information or www.panduit.com.

IndustrialNet™ RJ45 Patch Cords



ISTPHCH1MTL

Part Number	Description	Std. Pkg. Qty.	Std. Ctn. Qty.
ISTPHCH1MTL	Category 5e 600V 24 AWG stranded SF/UTP patch cord, RJ45 plug to RJ45 plug, 1 metre, Teal.	1	10
ISTPHCH2MTL	Category 5e 600V 24 AWG stranded SF/UTP patch cord, RJ45 plug to RJ45 plug, 2 metre, Teal.	1	10
ISTPHCH3MTL	Category 5e 600V 24 AWG stranded SF/UTP patch cord, RJ45 plug to RJ45 plug, 3 metre, Teal.	1	10
ISTPHCH5MTL	Category 5e 600V 24 AWG stranded SF/UTP patch cord, RJ45 plug to RJ45 plug, 5 metre, Teal.	1	10
ISTPHCH10MTL	Category 5e 600V 24 AWG stranded SF/UTP patch cord, RJ45 plug to RJ45 plug, 10 metre, Teal.	1	10

Standard lengths are from 0.3 meters to 40 meters. Contact Panduit Customer Service for additional colours and lengths.

IndustrialNet™ IP67 RJ45 Patch Leads



ISTPSP1MBL

Part Number	Description	Std. Pkg. Qty.	Std. Ctn. Qty.
ISTPSP1MBL	Category 6 industrial 24 AWG stranded SF/UTP patch cord, IP67 RJ45 plug to IP67 RJ45 plug with captive dust caps, 1 metre, Black.	1	10
ISTPSP2MBL	Category 6 industrial 24 AWG stranded SF/UTP patch cord, IP67 RJ45 plug to IP67 RJ45 plug with captive dust caps, 2 metre, Black.	1	10
ISTPSP3MBL	Category 6 industrial 24 AWG stranded SF/UTP patch cord, IP67 RJ45 plug to IP67 RJ45 plug with captive dust caps, 3 metre, Black.	1	10
ISTPSP5MBL	Category 6 industrial 24 AWG stranded SF/UTP patch cord, IP67 RJ45 plug to IP67 RJ45 plug with captive dust caps, 5 metre, Black.	1	10
ISTPSP10MBL	Category 6 industrial 24 AWG stranded SF/UTP patch cord, IP67 RJ45 plug to IP67 RJ45 plug with captive dust caps, 10 metre, Black.	1	10

Industrial Networks

IndustrialNet™ Connectors



IAEBH**



IAEFP1



ISPS688FA



ISPS5E44MFA
ISPS6A88MFA



ICAM12DRJS



ICAM12X90RJS

Part Number	Description	Std. Pkg. Qty.	Std. Ctn. Qty.
Industrial Bulkhead Connector with Protective Cover			
IAEBH6S	Category 6 Variant 1 IP67 rated RJ45 connector, STP.	1	10

Faceplates

IAEFP1	Stainless steel faceplate, single gang, accepts one bulkhead connector.	1	10
IAEFP2-2G	Stainless steel faceplate, double gang, accepts two bulkhead connectors.	1	10

Industrial RJ45 Plug

ISPS688FA	Category 6A RJ45 plug for 24-22 AWG solid, 1.0 – 1.6mm conductor diameter, UTP and STP.	1	10
-----------	---	---	----

Industrial M12 Connectors

ISPS5E44MFA	Category 5e M12 D-Code STP field terminable connector, male.	1	25
ICAM12DRJS	Category 5e M12 D-Code to RJ45 industrial adapter, panel mount.	1	10
ICAM12XRJS	Category 6A M12 X-Code to RJ45 industrial adapter, straight, panel mount.	1	15
ISPS6A88MFA	Category 6A M12 X-Code STP field terminable connector, male.	1	10

Field Term RJ45 Plug



FP6X88MTG



FPUD6X88MTG

Part Number	Description	Std. Pkg. Qty.	Std. Ctn. Qty.
Straight Cable Entry			
FP6X88MTG	Category 6A UTP field term RJ45 plug.	1	50
FP6X88MTG-X	Category 6A UTP field term RJ45 plug, package of ten.	10	100
Angled Cable Entry			
FPUD6X88MTG	Category 6A UTP angled field term RJ45 plug.	1	50
FPUD6X88MTG-X	Category 6A UTP angled field term RJ45 plug, package of ten.	10	100
Straight Cable Entry – Shielded			
FPS6X88MTG	Category 6A shielded field term RJ45 plug.	1	50
FPS6X88MTG-X	Category 6A shielded field term RJ45 plug, package of ten.	10	100
Test Cord			
FP6X88TC	Field term RJ45 plug test cord, Red, 1 metre.	1	1

Industrial Networks

DIN Rail Mount Enclosures and Accessories



Part Number	Description	Std. Pkg. Qty.	Std. Ctn. Qty.
CDPP8RG	8 port DIN rail mount patch panel, suits single Mini-Com™ Modules, Grey.	1	25
FDME8RG	8 port DIN rail fibre optic patch panel, suits single Mini-Com™ Modules, includes cable entry gland, Grey.	1	10
CADIN1IG	Mini-Com DIN rail mount module, suits single Mini-Com™ Modules, Grey.	1	15
IABDIN4	DIN rail on 19 inch 4 RU recessed rack mount frame, Black.	1	15

Industrial Network Uninterruptible Power Supply (UPS)



Part Number	Description	Std. Pkg. Qty.	Std. Ctn. Qty.
UPS00100DC	Uninterruptible power supply (UPS), 100 watt; no-battery, maintenance-free with remote management; 24 – 28 VDC in/out; wide operating temperature range: -40°C to +60°C; DIN rail mount.	1	—

Industrial Networks

Industrial Network Zone Enclosures



Z23C-6



Z11C-6

- IP66, industrial automation zone enclosures
- Accommodate one or two industrial switches and power supply
- Removable pre-engineered back plate with DIN rails
- Pre-installed accessory side panels, fibre slack spool, and cable management L rings
- Door can be hinged on the right or left and is equipped with 3mm double bit latches
- Available in pre-configured versions complete with industrial switch, UPS and patch cords

Go to Panduit.com to see the full range of enclosures or contact your Panduit representative.

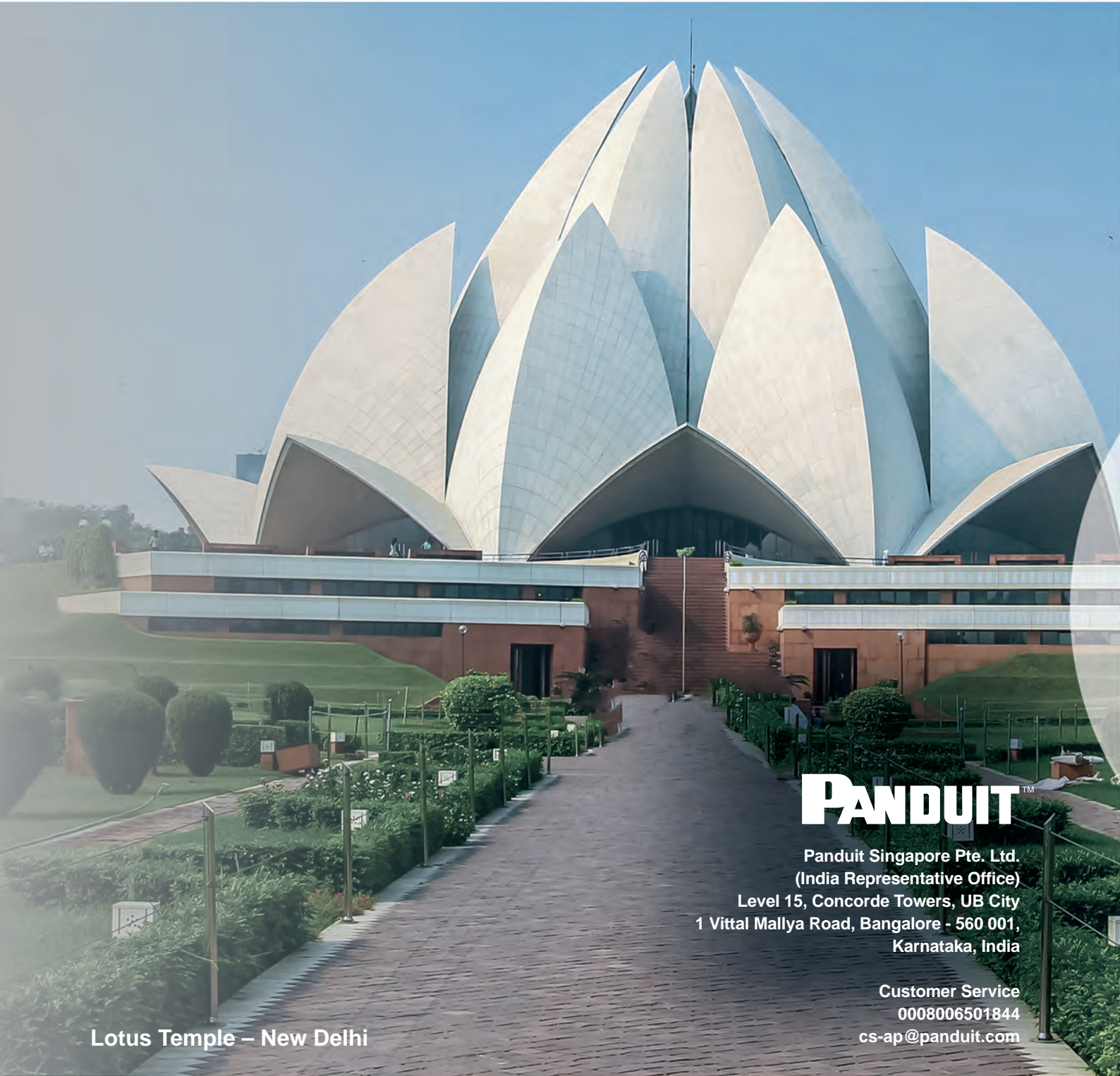

PANDUIT[™]

Panduit Singapore Pte. Ltd.
(India Representative Office)
Level 15, Concorde Towers, UB City
1 Vittal Mallya Road, Bangalore - 560 001,
Karnataka, India

Customer Service
0008006501844
cs-ap@panduit.com

Lotus Temple – New Delhi