

PANDUIT LABEL APPLICATOR SYSTEM WEB BROWSER INTERFACE AND FIRMWARE UPDATE INSTRUCTIONS

© Panduit Corp. 2021

Original Instructions

This manual contains instructions for the following:

PLA-100

Label Applicator System

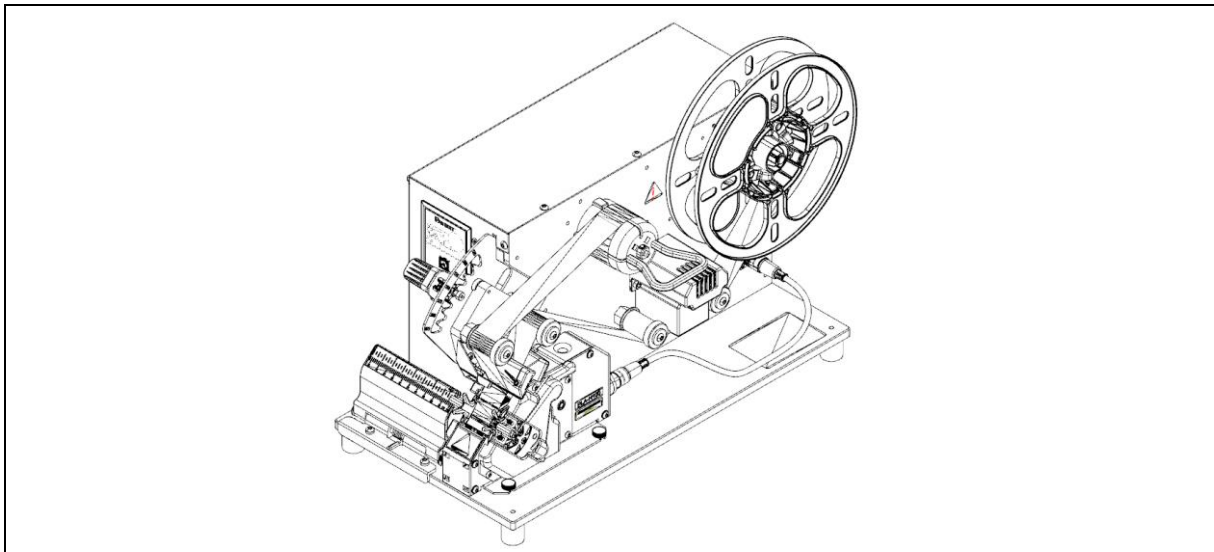

WARNING



- TO REDUCE THE RISK OF INJURY, USER MUST READ INSTRUCTION MANUAL

Email:
Ga-techsupport@panduit.com

EU Website:
www.panduit.com/emea

EU Email:
emeatoolservicecenter@panduit.com

PANDUIT

www.panduit.com

For Technical Support
USA & Canada: **1-866-871-4571**
Latin America: **+52-33-3777-6000**
Europe: **+31-546-580-452**
Asia Pacific Region: **65-6379-6700**
Japan: **81-3-6863-6060**

Contents

1: INTRODUCTION.....3

2: WEB BROWSER INTERFACE4

 2A: Status Via PC.....4

 2B: Connecting to the PLA System.....4

 2C: MODULE STATUS5

 2D: Network.....6



 2E: Device Name6







 2F: Network Settings7

 2G: WEB Browser Settings.....8

1: INTRODUCTION

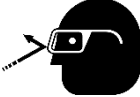
The following are the instructions to setup and operate the Panduit Label Applicator Systems. The Panduit Label Applicator System developed by Panduit Corporation provides customers with a means to apply Panduit self-laminated labels to both rigid and flexible cables for high volume wire harnessing applications.

	CAUTION: SAFETY GLASSES WITH SIDE SHIELDS MUST BE WORN AT ALL TIMES DURING THE OPERATION, MAINTENANCE OR ADJUSTMENT OF THE LABEL APPLICATOR.
	CAUTION: ELECTROSTATIC SENSITIVE DEVICE. DO NOT OPEN OR HANDLE EXCEPT AT A STATIC FREE WORKSTATION.

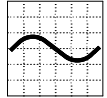
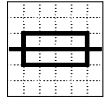
SYMBOL	EXPLANATION
	Warning: Hazardous Voltage Disconnect power before servicing
	Warning: Moving Parts
	Warning: Wear Safety Glasses
	Caution
	WEEE Compliance
	Read the Manual
	VAC
	FUSE

2: WEB BROWSER INTERFACE

The PLA SYSTEM web server has been tested with Microsoft Internet Explorer 11 and Google Chrome 77.X, running on Windows 7 and Windows 10 operating systems. Other web browsers and operating systems may work as well, but proper operation is not guaranteed. The appearance of the WBI can be adjusted through the web browser settings.

2A: Status Via PC

Status information for the PLA SYSTEM may be accessed by running a web browser on a PC that is connected to the same network to which the PLA SYSTEM is connected. The Network is accessed via the Ethernet port located on the back of the dispenser. The connection is a standard RJ-45 type receptacle. This port should be connected to a router running a DHCP server. The PLA SYSTEM will be assigned an IP address by the DHCP server running on the network. The network can be configured to assign either a static or dynamic IP address to the PLA SYSTEM. Consult with the network administrator as to how to determine the assigned IP address.

2B: Connecting to the PLA System

Within the web browser address bar type “http://nnn.nnn.nnn.nnn” where nnn.nnn.nnn.nnn is the IP address assigned to the PLA SYSTEM unit by the network.

2C: MODULE STATUS

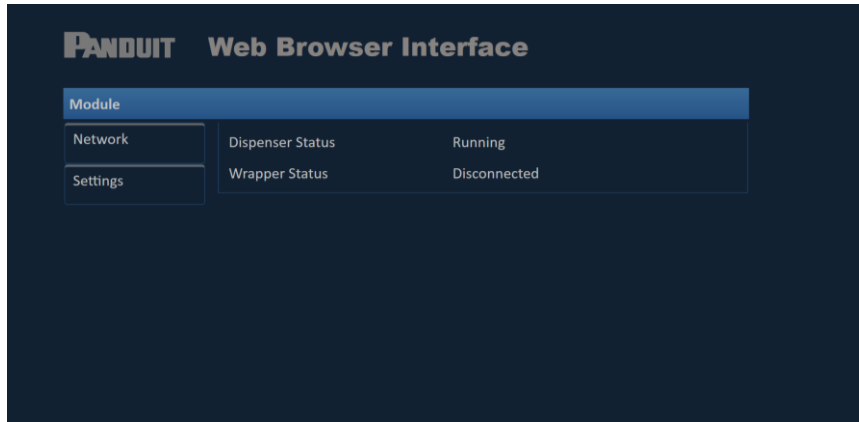

NOTE: No username and password authentication is required to view the Module page.

The Module Status indicates the general state of the PLA SYSTEM. A table of Module Status states is below. Minor Faults may be corrected by a Reset. Major faults may be corrected by using the Restore Factory Defaults. If normal operation does not follow after a “Restore”, please contact Panduit for technical support or service.

Wrapper Status	Description
Disconnected	Wrapper is not connected to the dispenser
Running	Wrapper is operating correctly
Idle	Waiting
Error	Wrapper has a fault
Dispenser Status	Description
Running	Dispenser is operating correctly
Error	Dispenser has a fault

2D: Network

USERNAME AND PASSWORD



When first accessing the Network and Setting pages on the PLA SYSTEM; or after approximately 30 minutes of inactivity, entry of a Username and Password is required. The default Username is “Panduit PLA” and the default Password is “password”.

NETWORK STATUS



The Network Status indicates the state of the Ethernet/IP connection. Ethernet IP is not supported for this product and this field should be ignored.

2E: Device Name

The Device Name parameter is used as the text in the Web Interface window. In addition to providing a convenient way to identify one device (e.g. “Plant 1 Line G”), having different Device Names allows multiple PLA SYSTEM windows to be displayed, each with a unique name in the Title Bar, allowing one screen to view multiple devices on a network. The Device Name can be edited by clicking on the

“Change” button immediately to the right. The Device Name can be restored to the factory default value as described in *Restore* section on Page 32.



2F: Network Settings

The Network Settings shows the current method the PLA SYSTEM uses to obtain an IP Address on the network, the current IP Address, the Network Mask and Gateway address values. In the default DHCP setting, the PLA SYSTEM will connect to the network and look for a DHCP server to issue an IP Address. The IP Address Mode can be changed to Static by clicking on the “Change” button immediately to the right.

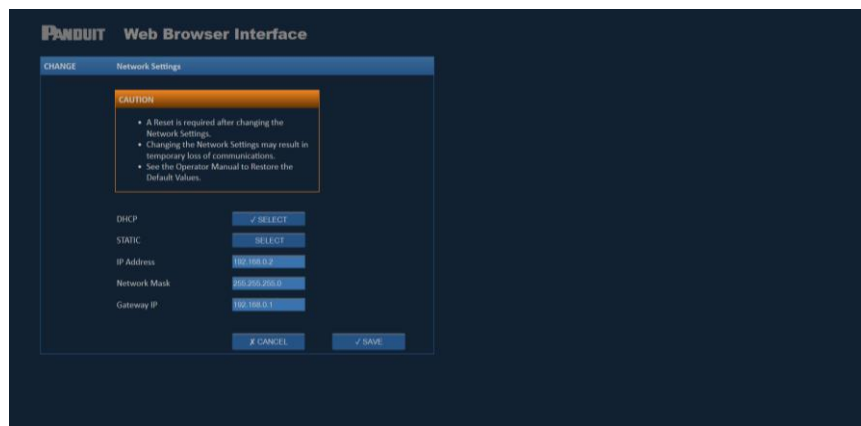

When the IP Address Mode is changed, an IP Address, an optional Network Subnet Mask and optional Gateway address can also be entered. The IP Address Mode can be restored to the factory default value as described in *Restore* section on Page 32.

2G: WEB Browser Settings



See *Username and Password* on Page 29 for username and password authentication.

MODEL

The Model displays the Model Number of this PLA SYSTEM (PATGEN4.0).

RESET

The Reset button can be used to restart the PLA SYSTEM in the event of a Minor or Major Fault, or after a change to Network Settings, or performing a Restore Factory Defaults or Firmware Update.

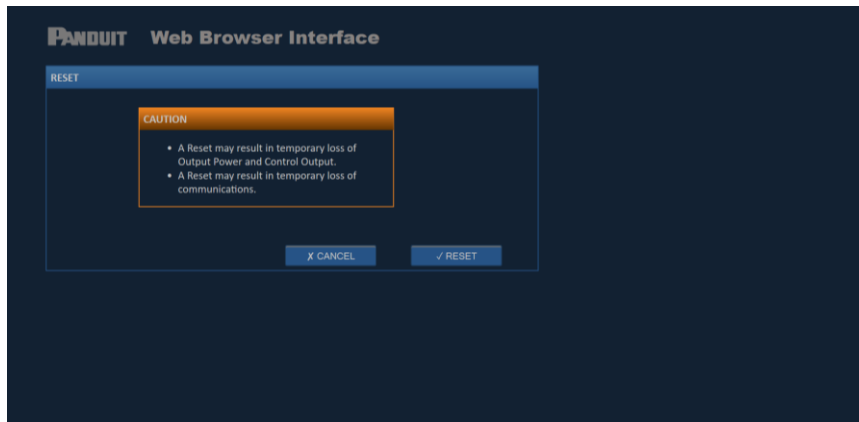

SERIAL NUMBER

The Serial Number displays the Serial Number of this PLA SYSTEM device, which is also printed onto a label on the side of the unit.

FIRMWARE VERSION

The firmware version is displayed. To check for firmware updates, please visit Panduit.com and click on Support and follow the links to the PLA SYSTEM Firmware Update page.

UPDATE

Clicking on the UPDATE button will prompt the user to browse and locate the firmware file named “image.bin” for uploading, as shown below.



The firmware file should be downloaded and placed on an accessible network drive. After the “image.bin” file is located and the UPDATE button is clicked, the PLA SYSTEM will import and update its software using the new image. After performing a firmware update, the user should immediately cycle the power.

MAC ID

The MAC ID (Ethernet adapter device identifier) is displayed. The MAC ID is also printed on a label affixed to the side of the PLA SYSTEM.

RESTORE

Clicking on the Restore button will prompt the user to confirm before setting parameters back to their factory default values. After a restore to factory defaults, the user should perform a *Reset* (Page 31).



LANGUAGE

The current Language for the WBI is displayed. Clicking on the arrow displays a menu of available Languages. Clicking on a different language followed by clicking on the SAVE button immediately to the right will change the Language setting. After changing the Language, the user should perform a *Reset* (Page 31) for the new Language to take effect.



Email:
Ga-techsupport@panduit.com

EU Website:
www.panduit.com/emea

EU Email:
emeatoolservicecenter@panduit.com

PANDUIT

www.panduit.com

For Technical Support
 USA & Canada: **1-866-871-4571**
 Latin America: **+52-33-3777-6000**
 Europe: **+31-546-580-452**
 Asia Pacific Region: **65-6379-6700**
 Japan: **81-3-6863-6060**