

THIS COPY IS PROVIDED ON A RESTRICTED BASIS AND IS NOT TO BE USED IN ANY WAY DETRIMENTAL TO THE INTERESTS OF PANDUIT CORP.

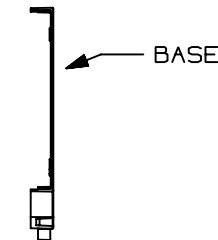

PANDUIT P/N	WEIGHT
T702T	14.3 LB/10 PCS (6508 g/10 PCS)

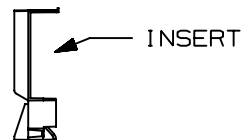
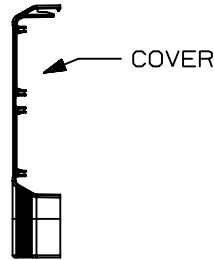
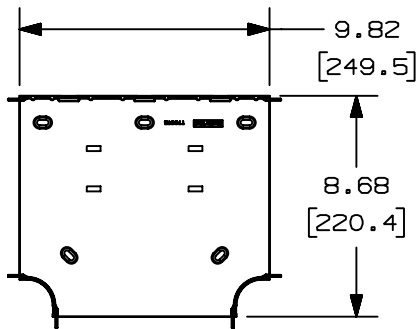
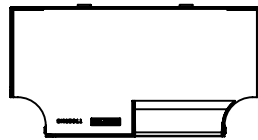
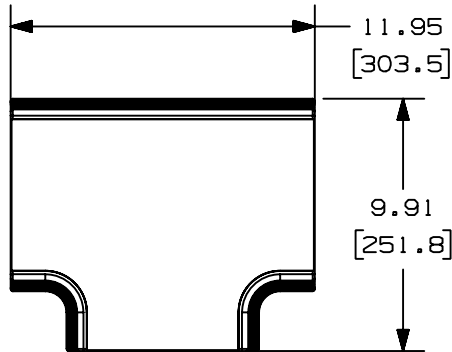

NOTES:

1. SEE CURRENT CATALOG FOR ADDITIONAL PART SUFFIXES TO INDICATE COLOR AND OR PACKAGE QUANTITY.
2. THIS PRODUCT IS FEATURED WITH THE TIA/EIA COMPLIANT BEND RADIUS.
3. BREAKOUTS FOR MAINTAINING POWER AND DATA ENTRY SEPARATION.
4. COVER IS EXTENDED OUT AND DOWN AROUND SIDES OF BASE WHEN ASSEMBLED.
5. DIMENSIONS IN PARENTHESES ARE IN METRIC.

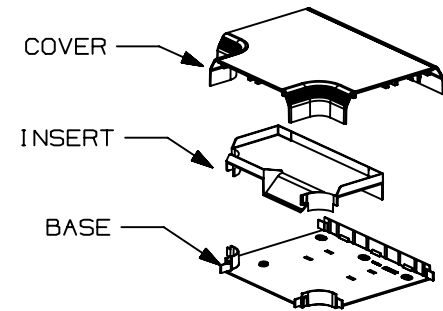

CAD FILENAME/LAYERS D34866EB\_DC\_T702TF\_01

PANDUIT CORP. TINLEY PARK, ILLINOIS

TWIN-70 TEE FITTING  
(T702T)  
CUSTOMER DRAWING

UNLESS OTHERWISE SPECIFIED,  
DIMENSIONAL TOLERANCES ARE:  
(.X) ± (.XXX) ±  
(.XX) ±.03(.8) ANGLES ±

UNLESS OTHERWISE SPECIFIED,  
ALL DIMENSIONS ARE GIVEN  
IN INCHES, THIRD ANGLE PROJECTION.

REV	DATE	BY	CHK	DESCRIPTION	ECN	CHK	CUST	SUP
I	07-29-99	DW	HIW	A. REVISED MATERIAL AND WEIGHT.	34866-90	HIW	HIW	
R	04-07-98	DW	HIW	RELEASED TO PRODUCTION.	34866-90	HIW	HIW	

DRAWN BY DW	MAT'L: PVC	SCALE NONE
DATE 04-07-98		DRAWING NO. 34866-90
CHECKED BY HIW		DWG A SIZE